

# OPERATING MANUAL

# **DUOLENT**

**DX 210 N | DX 300 N | DX 350 N**

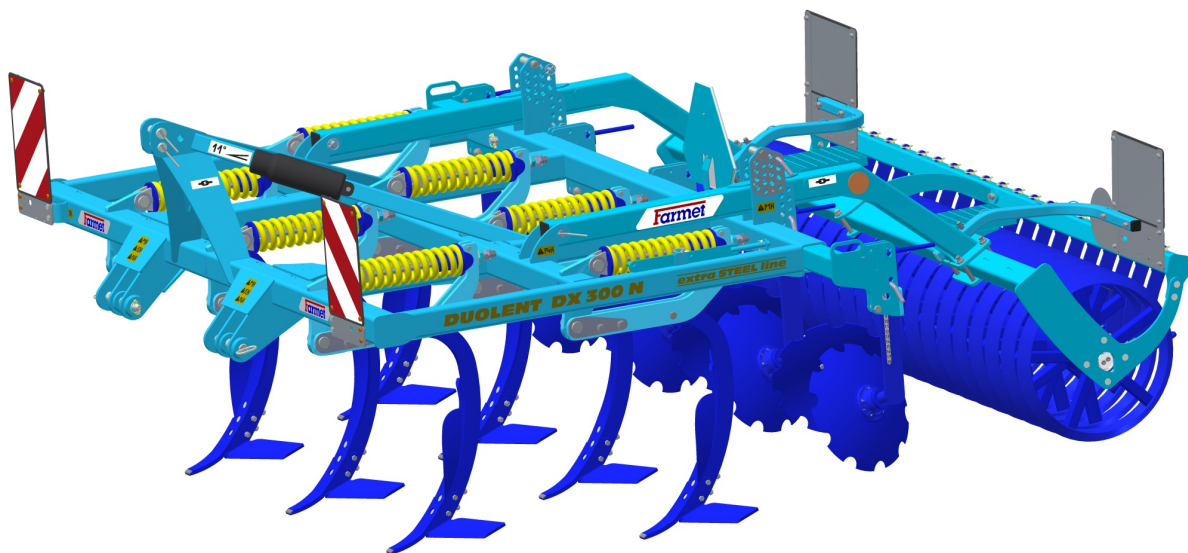

Edition: 5 Effective from: 01.11.2017

FARMET a.s.  
Jiřinková 276  
552 03 Česká Skalice, CZ

phone: +420 491 450 111  
fax: +420 491 450 136  
GSM: +420 774 715 738

IČ: 46504931  
DIČ: CZ46504931

www.farmet.cz  
e-mail: farmet@farmet.cz



## PREFACE

Dear customer,

The agricultural machine you have purchased is a high-quality product of Farmet a.s. Česká Skalice.

You can fully utilise the advantages of your machine after thoroughly studying the operating manual.

The serial number of the machine is punched on the production label and written in the operating manual (Your Machine Characteristics). This machine serial number must be stated whenever ordering spare parts for possible repairs. The production label is located on the frame .

Use only spare parts for these machines according to the **Spare parts catalogue** officially issued by the manufacturer, Farmet a.s. Česká Skalice.

### POSSIBILITIES OF USE OF YOUR MACHINE

The cultivator **DUOLENT** is designed for cultivation of all types of soils up to a processing depth of 35 cm (13,8 in).

### YOUR MACHINE CHARACTERISTICS :

MACHINE TYPE :

MACHINE SERIAL NUMBER :

SPECIAL DESIGN OR ACCESSORIES :

|  |
|--|
|  |
|  |
|  |

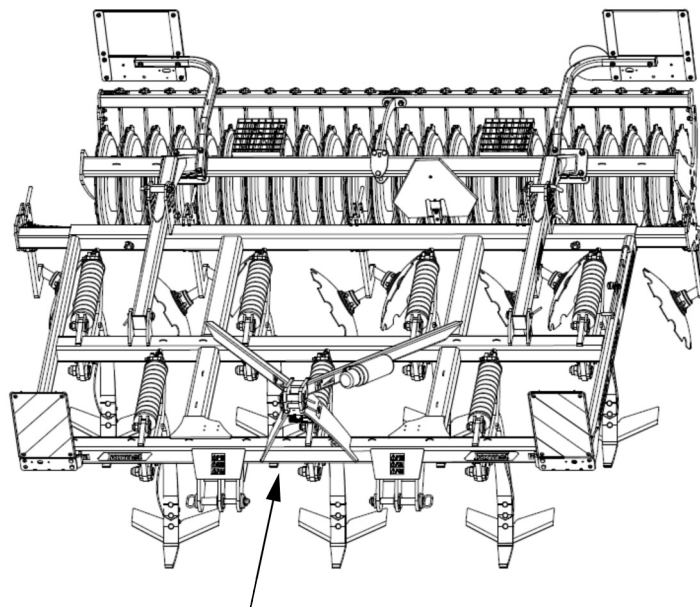

**IMPORTANT**

**READ CAREFULLY BEFORE USE**

**KEEP FOR FUTURE REFERENCE**

---

## Contents

|   |    |
|---|----|
| PREFACE .....   | 3  |
| 1 MACHINE LIMIT PARAMETERS .....                                | 7  |
| 1.1 Technical parameters.....                                   | 8  |
| 1.2 Safety statement.....                                       | 8  |
| 2 GENERAL INSTRUCTIONS FOR USE .....                            | 9  |
| 3 MACHINE TRANSPORT USING TRANSPORT MEANS .....                 | 11 |
| 4 MACHINE HANDLING USING LIFTING EQUIPMENT .....                | 12 |
| 5 WORK SAFETY LABELS .....                                      | 13 |
| 6 DESCRIPTION.....  | 16 |
| 6.1 Working parts of the machine .....                          | 16 |
| 6.1.1 Description and setting of the ring roller .....          | 17 |
| 7 MACHINE ASSEMBLY AT THE CUSTOMER.....                         | 18 |
| 8 COMMISSIONING.....  | 19 |
| 8.1 Agregation to a tractor .....                               | 20 |
| 9 MACHINE TRANSPORT ON ROADS.....                               | 21 |
| 10 MACHINE ADJUSTMENT .....                                     | 23 |
| 10.1 Adjusting the working depth of the machine .....           | 23 |
| 10.2 Share securing.....  | 25 |
| 10.3 Placement of top left and right shares on the machine..... | 26 |
| 11 MACHINE MAINTENANCE AND REPAIRS.....                         | 28 |
| 12 MACHINE STORAGE.....   | 29 |
| 13 ENVIROMENTAL PROTECTION .....                                | 30 |
| 14 MACHINE DISPOSAL AFTER SERVICE LIFE EXPIRY.....              | 31 |
| 15 SERVICING AND WARRANTY CONDITIONS .....                      | 32 |
| 15.1 Servicing .....  | 32 |
| 15.2 Warranty .....   | 32 |



## 1 MACHINE LIMIT PARAMETERS

- The machine is designed for soil cultivation up to a depth of 35 cm (13.8 in) when agricultural soil cultivation. Another type of use exceeding the determined purpose is forbidden.
- The machine is only operated by one person – the tractor driver.
- Machine operator must not use the machine in a different way, especially:
  - Transport of persons and animals on the machine structure,
  - Transport of burdens on the machine structure,
  - Aggregation of the machine with another towing equipment than stated in Chapter 8.1.

## 1.1 Technical parameters

| PARAMETERS              | DUOLENT DX 210 N                   | DUOLENT DX 300 N                   | DUOLENT DX 350 N                   |
|-------------------------|------------------------------------|------------------------------------|------------------------------------|
| Working width           | 2,1m (6,89 ft)                     | 3 m (9,84 ft)                      | 3,5 m (11,48 ft)                   |
| Transport width         | 2,23 m (7,32 ft)                   | 3 m (9,84 ft)                      | 3,5 m (11,48 ft)                   |
| Transport height        | 1,4 m (4,6 ft)                     |                                    |                                    |
| Machine total length    | 3,35 m (11 ft)                     |                                    |                                    |
| Working depth           | max 35 cm (13,8 in)                |                                    |                                    |
| Number of shares        | 5                                  | 7                                  | 9                                  |
| Working performance     | 1,7 – 2,5 ha/h<br>(4,2 – 6,2 ac/h) | 2,4 – 3,6 ha/h<br>(9,9 – 8,9 ac/h) | 2,8–4,2 ha/h<br>(6,9–10,4 ac/h)    |
| Towing means            | 65 – 110 kW<br>(85 – 145 HP)*      | 90 – 160 kW<br>(120 – 215 HP)*     | 105 – 185 kW<br>(140 – 245 HP)*    |
| Working speed           | 8–12 kph (5 - 7,5 mph)             |                                    |                                    |
| Maximum transport speed | 20 kph (12,4 mph)                  |                                    |                                    |
| Maximum slope grade     | 6 (°)                              |                                    |                                    |
| Machine weight          | 1035 – 1100 kg<br>(2280 – 2425 lb) | 1310 – 1405 kg<br>(2890 – 3095 lb) | 1475 – 1585 kg<br>(3250 – 3495 lb) |

\* Recommended towing means, the real towing force may significantly vary according to the processing depth, soil conditions, land slope, working body wear and adjustment

## 1.2 Safety statement



This warning sign warns about an immediate dangerous situation ending with death or severe injury.





This warning sign warns about a dangerous situation ending with death or severe injury.



This warning sign warns about a situation that may end with a smaller or slight injury. It also warns about dangerous actions related to the activity that could lead to an injury.



## 2 GENERAL INSTRUCTIONS FOR USE

- The machine is made in accordance with the latest equipment state and approved safety regulations. However, dangers of user or third person injury or machine damage or creation of other material damage may arise during use.
- Use the machine only in a technically sound condition, in accordance with its purpose, aware of possible dangers, and while adhering to the safety instructions of this operating manual!  
The Manufacturer is not liable for damages caused by the use of the machine that is in contradiction with the limit parameters of the machine and with the instructions for the use of the machine. The User bears the risk.  
Immediately remove especially the failures that may negatively affect safety!
- Machine operation may be performed by a person authorised by the operator under these conditions:
  - It must own a valid driver's licence of the corresponding category,
  - It must be demonstrably familiarised with the safety regulations for work with the machine and must practically master the machine operation,
  - The machine may not be operated by juveniles,
  - It must know the meaning of the safety signs located on the machine. Their respecting is important for safe and reliable machine operation.
- Maintenance and servicing repairs on the machine may only be performed by a person :
  - Authorised by the operator,
  - Educated in the machinery field with knowledge of repairs of similar machines,
  - Demonstrably familiarised with safety regulations for work with the machine,
  - During a repair of a machine connected to a tractor, it must own a driver's licence of the corresponding category.
- Machine operator must secure the safety of other persons when working with the machine or transporting the machine.
- During machine work in the field or during transport, the operator must control the machine from the tractor's cabin.
-  The operator may enter the machine structure only with the machine at rest and blocked against movement, namely only for these reasons:
  - Adjustment of the machine working parts,
  - Repair and maintenance of the machine,
-  When stepping on the machine, do not step on roller tyres or other rotary parts. Those may turn and you can cause very serious injuries by the subsequent fall.
-  Any changes or modifications of machine may be performed only with written consent of the manufacturer.  
For possible damage arisen due to ignoring this instruction, the producer bears no responsibility.  
The machine must be maintained equipped with prescribed accessories and equipment including safety marking.  
All warning and safety signs must be legible and in their places. In case of damage or loss, these signs must be immediately renewed.
- The operator must have the Operating Manual with the work safety requirements available at any time when working with the machine.



- The operator must not consume alcohol, medicines, narcotic and hallucinogenic substances that decrease his attention and coordination capabilities while using the machine.  
If the operator must use medicines prescribed by a physician or uses freely sold medicines, he must be informed by a physician, whether he is capable of responsible and safe operation of the machine under these circumstances.

### Protective tools :



For operation and maintenance use:



- tight clothes
- protective gloves and goggles against dust and sharp parts of the machine



### 3 MACHINE TRANSPORT USING TRANSPORT MEANS

- The transport means designed for machine transport must have the load capacity minimally identical with the weight of the transported machine. The total weight of the machine is stated on the production label.
- The dimensions of the transported machine including the transport means must comply with the valid regulations for road traffic (decrees, laws).
-  • The transported machine must be always fastened to the transport means so that its spontaneous loosening could not happen.
- The carrier is responsible for damage caused by the loosening of incorrectly or insufficiently fastened machine to the transport means.

## 4 MACHINE HANDLING USING LIFTING EQUIPMENT

- The lifting equipment and tying means designed for handling of the machine must have their load capacity at least identical with the weight of the handled machine.
-  • Machine fastening for handling may only be performed in places designed for that and marked with self-adhesive labels showing the "chain" symbol. 
- After fastening (suspending) at designated points, it is forbidden to move in the space of possible reach of the handled machine.

## 5 WORK SAFETY LABELS

Warning safety labels serve for operator protection.

**General:**

- Strictly observe the warning safety labels.
- All safety instructions also apply to other users.
- Upon damage or destruction of the aforementioned "SAFETY LABEL" located on the machine, THE OPERATOR IS OBLIGED TO REPLACE IT WITH A NEW ONE!!!
- The position, appearance and the precise meaning of the work safety labels on the machine are determined in the following tables and the figure .

| WARNING SAFETY LABEL | LABEL TEXT   | MACHINE POSITION |
|----------------------|--|------------------|
|                      | <p>Before handling the machine, carefully read the operating manual.<br/>Observe the instructions and safety regulations for machine operation during use.</p>   | <b>P 1 H</b>     |
|                      | <p>When connecting or disconnecting, do not step between the tractor and the machine, also do not enter this space, if the tractor and the machine are not at rest and the engine is not turned off.</p>   | <b>P 2 H</b>     |
|                      | <p>Stay out of reach of the drawn-up machine.</p>  | <b>P 4 H</b>     |
|                      | <p>Stay outside the reach of the tractor - agricultural machine set, if the tractor engine is in operation.</p>  | <b>P 6 H</b>     |
|                      | <p>The side extensible disc must be secured with the stopper for transport and during work.<br/>The rear twin roller must be secured with the stopper for transport.<br/>Before commencing the machine transport, secure the axle with spherical valves against unexpected drop.</p> | <b>P 13 H</b>    |
|                      | <p>When folding the side frames, do not reach into the space of the machine folding joints.<br/>There is a danger of cutting when setting the depth of the machine.</p>  | <b>P 20 H</b>    |





|  |  |                       |
|--|--|-----------------------|
|  <p>P 37 H</p>    | <p>Travelling and transport on the machine structure is strictly forbidden.</p>                                      | <p><b>P 37 H</b></p>  |
|  <p>P 39 H</p>    | <p>When working and transporting the machine, maintain safe distance from the electric appliances.</p>               | <p><b>P 39 H</b></p>  |
|  <p>P 50 H</p>    | <p>When folding and unfolding the side frames, stay outside their reach.</p>   | <p><b>P 50 H</b></p>  |
|  <p>P 52 H</p>   | <p>Secure the machine against unwanted movement by positioning on its working bodies (shares).</p>                   | <p><b>P 52 H</b></p>  |
|  <p>P 53 H</p>  | <p>Do not approach the rotary parts of the machine, if these are not at rest, i.e. they do not turn.</p>             | <p><b>P 53 H</b></p>  |
|  <p>P 100 H</p> | <p>It is strictly folding and unfolding the side frames on slopes or inclined surfaces.</p>                          | <p><b>P 100 H</b></p> |
|  <p>P 101 H</p> | <p>The shown positions of the lever and the function of the hydraulic spherical valve located on the piston rod.</p> | <p><b>P 101 H</b></p> |

Fig. 1 - Location of safety labels on the machine

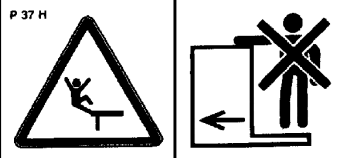
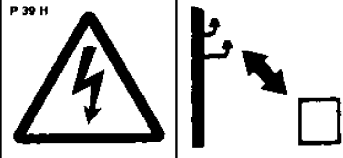

## 6 DESCRIPTION

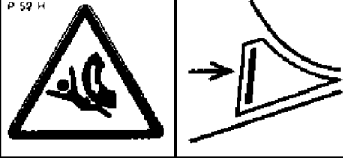
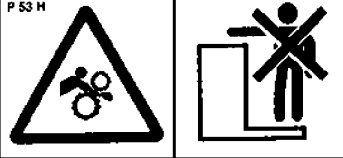
The machine **DUOLENT DX 210 S, DX 300 N, DX 350 N** is structurally solved as carried.

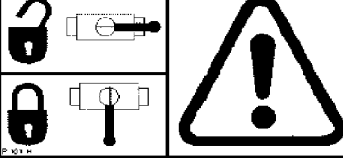
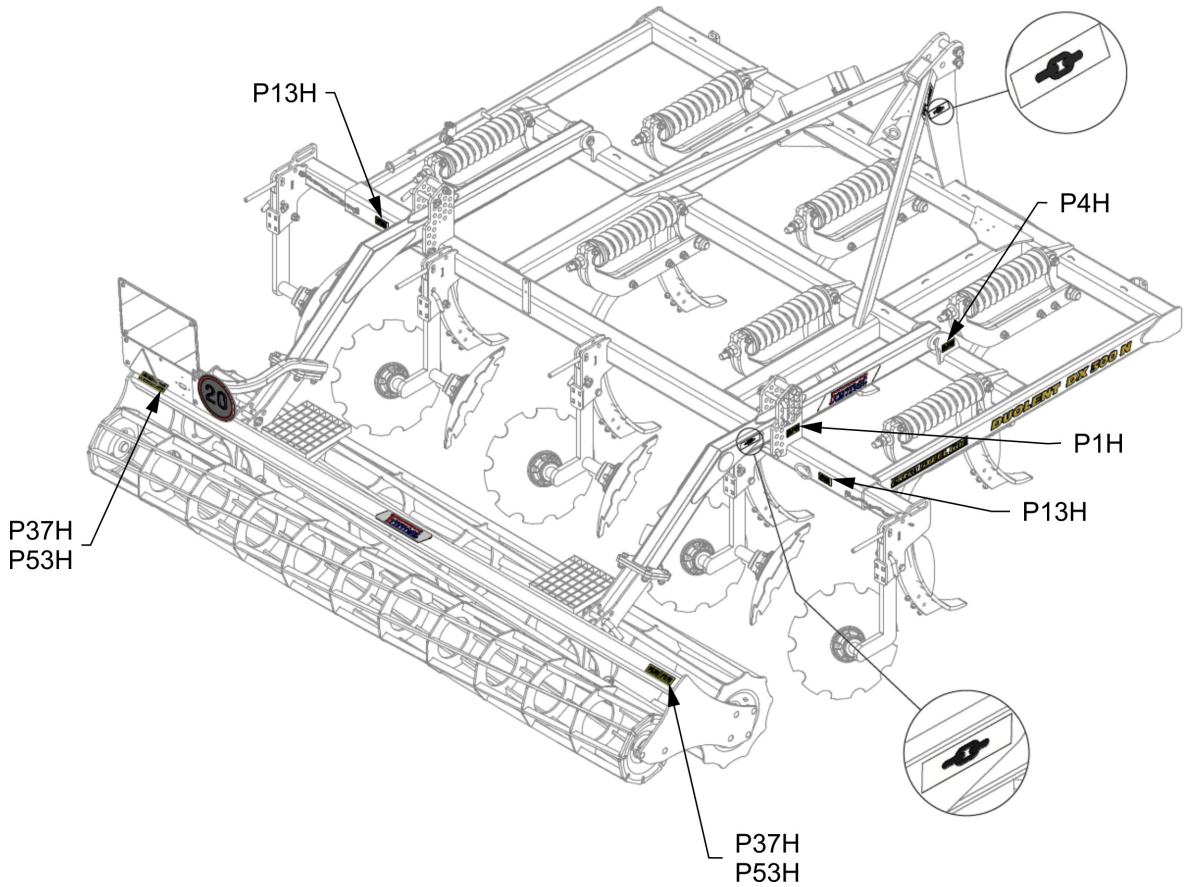
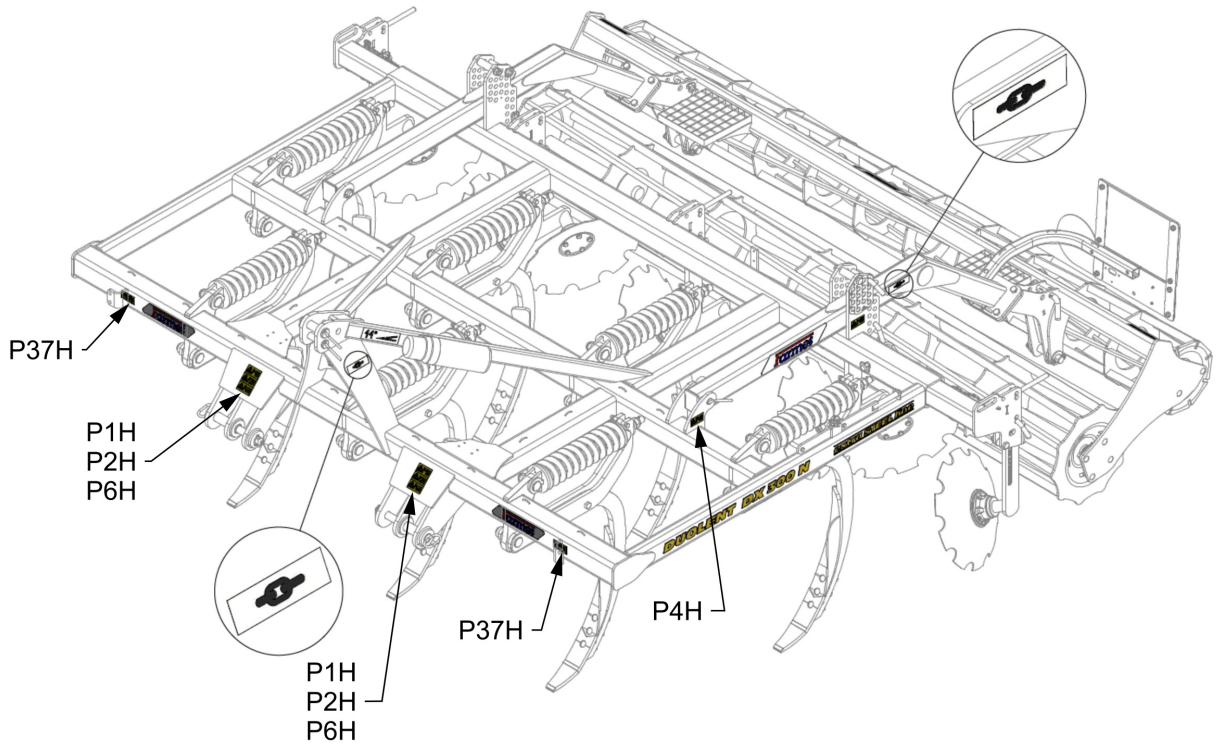
DX 210 N is equipped with TPS 2 suspension. DX 300 N and DX 350 N is equipped with TPS 2 and TPS 3 suspension. DUOLENT consists of a framework with two rows of shares with automatic spring protection. There is a row of discs on the rear crossbar of the framework. There are also swinging rear frames equipped with the rear roller attached to the main frame.

### 6.1 Working parts of the machine

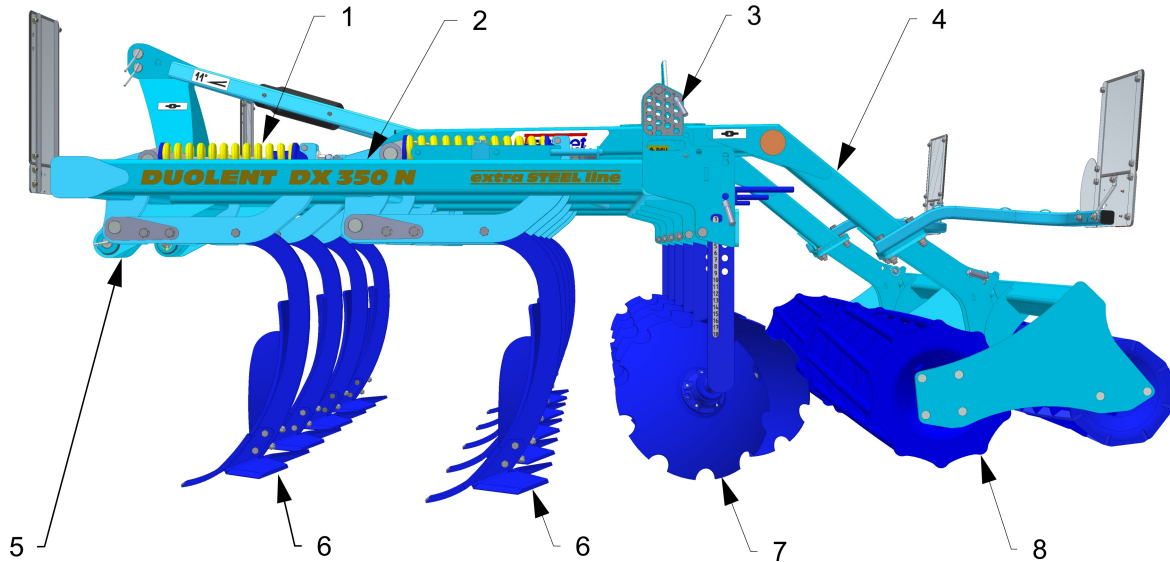

1. Spring protection
2. Machine framework
3. Setting the depth of the rollers
4. Rear roller framework
5. TPS towing suspension
6. Sections of shares in rowsscrewed chisels with cutting wings
7. Sections of angle discs
8. Rear roller



## 6.1.1 Description and setting of the ring roller

The roller with wheels consisting of ring segments is attached to the frame. There is a row of leveller blades in front of the roller. The height as well as angle of the blades can be adjusted. The correct setting of the blades is essential for the correct function of the roller. The setting of the blades must be first tested and adjusted under factual conditions.

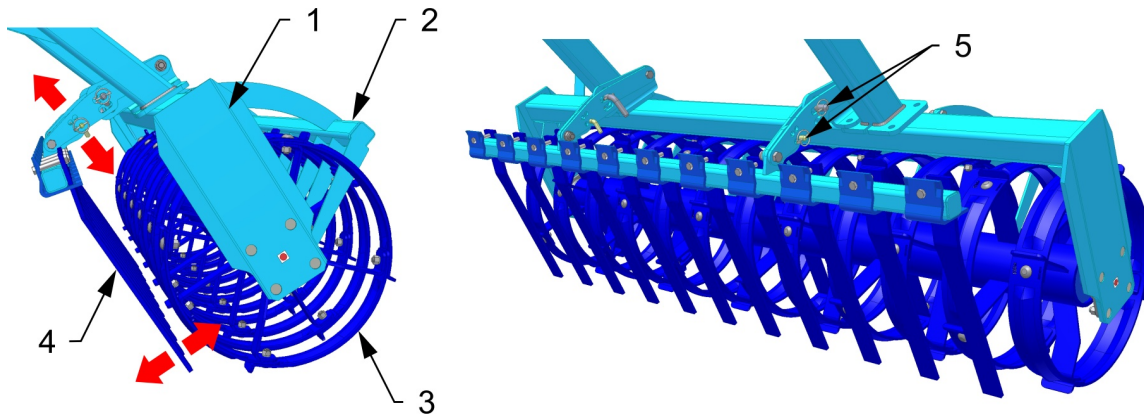

- 1. Roller frame
- 2. Roller cleaner
- 3. Roller
- 4. Front leveller blades
- 5. Bolts for adjusting leveller blades

### Possibilities for setting front leveller blades

1. Front leveller blades located in front of the roller wheels throw clods directly under the wheels that crush them.



2. Front leveller blades located between the roller wheels throw soil inside the wheels. Clods of soil are thus partially crushed by the wheels and partially crushed inside the wheels. With this setting, the surface is covered with soft soil after work.

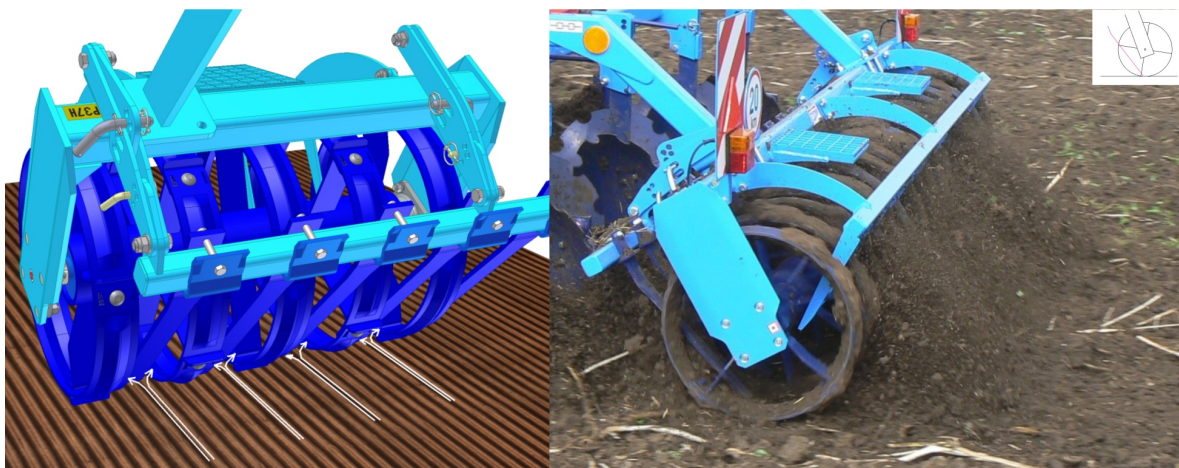

## 7 MACHINE ASSEMBLY AT THE CUSTOMER

- The operator must perform the assembly according to the instructions of the producer, best in cooperation with the expert servicing technician determined by the producer.
-  • The operator must secure a functional test of all assembled parts after the completion of the machine assembly.
- The operator must secure that the handling of the machine using lifting equipment during its assembly is in accordance with chapter „4“.

## 8 COMMISSIONING



- Before taking over the machine, test and check, whether damage occurred during transport and whether all parts contained in the bill of delivery were supplied.
- Before commissioning the machine, carefully read this operating manual, especially Chapters 1–5. Before the first use of the machine, familiarise yourselves with its controls and overall function.
- During work with the machine, observe not only the instructions of this operating manual but also generally valid regulations of work safety, health protection, fire and transport safety, and environmental protection.
- The operator must check the machine before every use (commissioning) from the standpoint of completeness, work safety, work hygiene, fire safety, transport safety, and environmental protection. A machine showing signs of damage must not be commissioned.
- Aggregation of the machine with the tractor is to be performed on a flat and hardened surface.
- When working on slopes, observe the lowest slope grade of the set **TRACTOR - MACHINE**.
- Before starting the tractor motor, check whether no person or animal is in the working space of the set and push the warning sound signal.
- The operator is responsible for the safety and all damage caused by the operation of the tractor and the connected machine.
- The operator is obliged to adhere to the technical and safety regulations of the machine determined by the producer when working.
- The operator is obliged to retract the working bodies of the machine from the ground when turning at the headland.
- The operator is obliged to observe the prescribed working depths and speeds stated in the manual in Chap.1 when working with the machine.
- The operator is obliged to lower the machine to the ground and secure the set against movement before leaving the tractor cabin.
- Lower the machine with caution so that the chisels and shares are not damaged by sharp lowering to the ground. Position the machine on a flat ground so that the weight of the machine is evenly transferred to all shares.

## 8.1 Agregation to a tractor

- The machine can be connected only to a tractor, whose curb weight is identical or higher than the overall weight of the connected machine.
- The machine operator must observe all generally valid regulations of work safety, health protection, fire safety, and environmental protection.
- The operator may connect the machine exclusively to a tractor that is equipped with a rear three-point suspension and a functional undamaged hydraulic system.
- The table of requirements for the towing means for work with the machine:

|   |  |  |
|---|--|--|
| Requirement for the tractor engine power for cultivator <b>DX 210 N</b> |  | <b>65 - 110 kW (85 - 145 HP)*</b>  |
| Requirement for the tractor's TPS                                       | Spacing of the lower suspension joints (measured at the joint axes)            | <b>870+/- 1,5 mm (34,25 in)</b>  |
|   | ∅ of the hole of the lower suspension joints for the machine suspension pivots | <b>28,7 - 29,03 mm (1,13 – 1,14 in)</b>  |
|   | ∅ of the hole of the upper suspension joint for the machine suspension pivot   | <b>25,7 - 25,91 mm (1,012 – 1,020 in)</b>                                      |
| Requirement for the tractor engine power for cultivator <b>DX 300 N</b> |  | <b>90 - 160 kW (120 - 215 HP)*</b>   |
| Requirement for the tractor engine power for cultivator <b>DX 350 N</b> |  | <b>105 - 185 kW (140 - 245 HP)*</b>  |
| Requirement for the tractor's TPS                                       | Spacing of the lower suspension joints (measured at the joint axes)            | <b>1010 ± 1,5 mm / 870 ± 1,5 mm (39,76 in / 34,25 in)</b>                      |
|   | ∅ of the hole of the lower suspension joints for the machine suspension pivots | <b>37,4 - 37,75 mm / 28,7 – 29,03 mm (1,472 – 1,486 in / 1,130 – 1,143 in)</b> |
|   | ∅ of the hole of the upper suspension joint for the machine suspension pivot   | <b>32,0 – 32,25 mm / 25,7 - 25,91 mm (1,260 – 1,270 in / 1,012 – 1,020 in)</b> |

\* Recommended towing means, the real towing force may significantly vary according to the processing depth, soil conditions, land slope, working body wear and adjustment.

- Connect the machine using the TPS suspension bar to the lower arms of the rear TPS of the tractor, secure the TPS arms using pins against disconnecting.
- Connect the third point of the tractor only to the circular hole both for work and transport.
- The machine aggregated with the tractor changes the distribution of the weight to the individual axles of the tractor. The weight of the front axle is reduced and therefore the controllability gets worse. It also affects braking properties.



**When connecting, no persons may stay in the space between the tractor and the machine.**

## 9 MACHINE TRANSPORT ON ROADS

### Transport Position of DUOLENT DX 210 N, DX 300 N, DX 350 N

- ❗ • Connect the machine by suspending on the tractor using the three-point suspension equipment .
- Insert the side angle discs on the main frame into the transport position (Fig.3).
- Turn over the rear twin roller and secure it with the stopper (Fig.5) – only if the machine is equipped with the rear twin roller.
- The machine must be equipped with removable shields with marking of contours, functional lighting, and the board of the rear marking for slow vehicles (according to ECE No. 69).
- The lighting must be activated during travelling on roads.
- The tractor must be equipped with a special light device of an orange colour, which must be activated during travelling on roads.
- The maximum transport speed during travelling on roads is **20 kph (12,4 mph)**.
- Secure the lower shoulders of the tractor TPS from side swing.

⚠ **Zákaz provozu za snížené viditelnosti!**

Fig. 2 - Side angle discs in the working position



Fig. 3 - Side angle discs in the transport position

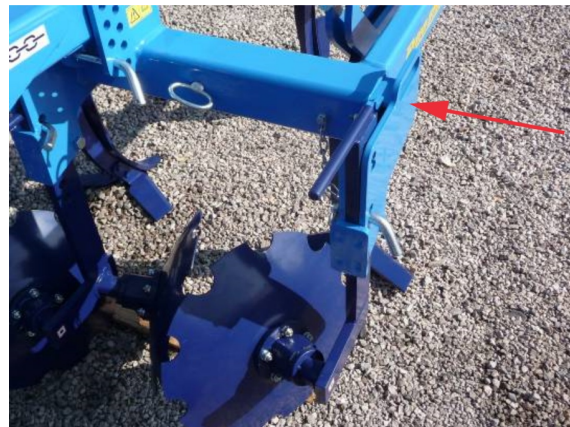

Fig. 4 - rear twin roller in the working position

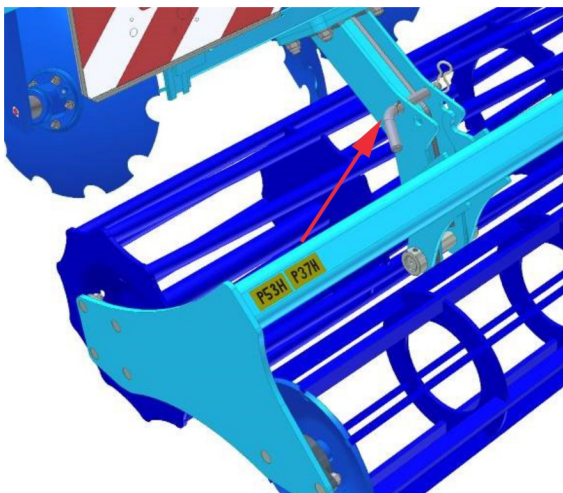
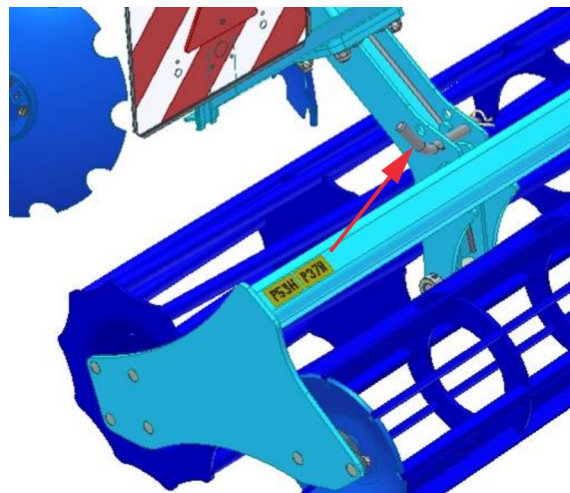

Fig. 5 - rear twin roller in the transport position



- Bring the machine into the transport position.
- The operator is obliged to pay increased attention during transport on roads, due to the transport dimensions of the machine.
- The operator must observe the valid regulations for transport on roads (laws, decrees) after connecting the machine to the tractor, for reason of a change of the axle load. The driving properties of the set also change depending on the terrain nature, adapt the manner of driving to these conditions.
- The operator is obliged to present the machine certificate of roadworthiness as needed, according to the valid regulations for road traffic (decree, law) (only in the Czech Republic).
- The transportation width of the **DX 350 N** machine is 3,5 m (11,48 ft), thus it is not possible to issue a certificate of roadworthiness for it in the Czech Republic.
- The operator is obliged to secure sufficient outlook during reversing from his position of the tractor driver. In case of insufficient outlook, the operator is obliged to call a competent and informed person.
- The operator must secure the arms of the rear TPS of the tractor in the transport position during road transport, i.e. prevent unexpected arm drop using the hydraulic arm control lever. At the same time, the arms of the rear TPS of the tractor must be secured against side swinging.
- During machine transport on roads, the operator must observe the valid laws and decrees that deal with this topic and which specify the relationships of the tractor axle load depending on transport speed.

## 10 MACHINE ADJUSTMENT

### 10.1 Adjusting the working depth of the machine

**!** Execute the adjustment only when the machine is set on the shares or when it is recessed (see below).

- !** 1. If the machine is equipped with a twin roller, first pull out the stopper securing the roller for transport.
2. Set the working depth by the upper stopper on the gate of the rear framework of the roller on the scale from 1 to 16.
3. Set the lengthwise level of the machine by the position of the bottom shoulders of the tractor and adjusting the drawbar of the third point of the tractor, this will ensure even processing depth of the first and second row of shares.
4. Set the working depth of the rectifying discs by moving them in the holders and changing the position of the stopper. Observe caution during the setting. Properly set discs will ensure perfect levelling and covering by fine soil in the whole width of the swathe. When the disc depth is too low, there are lines after the rear shares. When the discs are set too deep, there are tracks of heaped soil after the machine. Check the proper setting of the discs during work – the setting may vary due to the soil conditions and wear and tear of the discs.

You can use the auxiliary handle attached to the left side of the frame of the machine for disc setting. After putting the handle into the disc holder (Fig. 6) set the disc into the required position and secure with a stopper.

There is a label for disc depth setting is located on the left side rectifying disc for better arrangement (Fig.6). set the disc into the required position and secure with a stopper.

**!** **The working depth of the discs must never be identical with the working depth of the shares –“X”.**

5. Recess the machine into the soil, leave it recessed and secure the machine by the bottom stopper on the gate of the rear framework from undesirable falling of the rear frameworks with the roller on the main machine framework when working on the plough turning end. Push the stopper into the closest hole under the rear framework.
6. The depth setting must be the same on the left and right side of the machine.

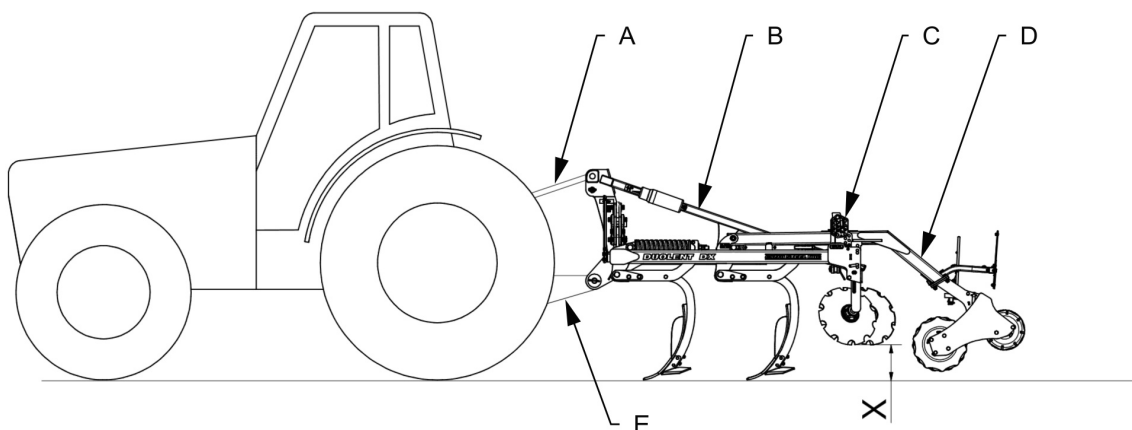

- A. Tractor's three-point pull rod
- B. Three-point flange
- C. Rear frame gates
- D. Rear swinging frames with rollers
- E. Tractor hydraulics arms

Fig. 6 - Machine adjustment procedure

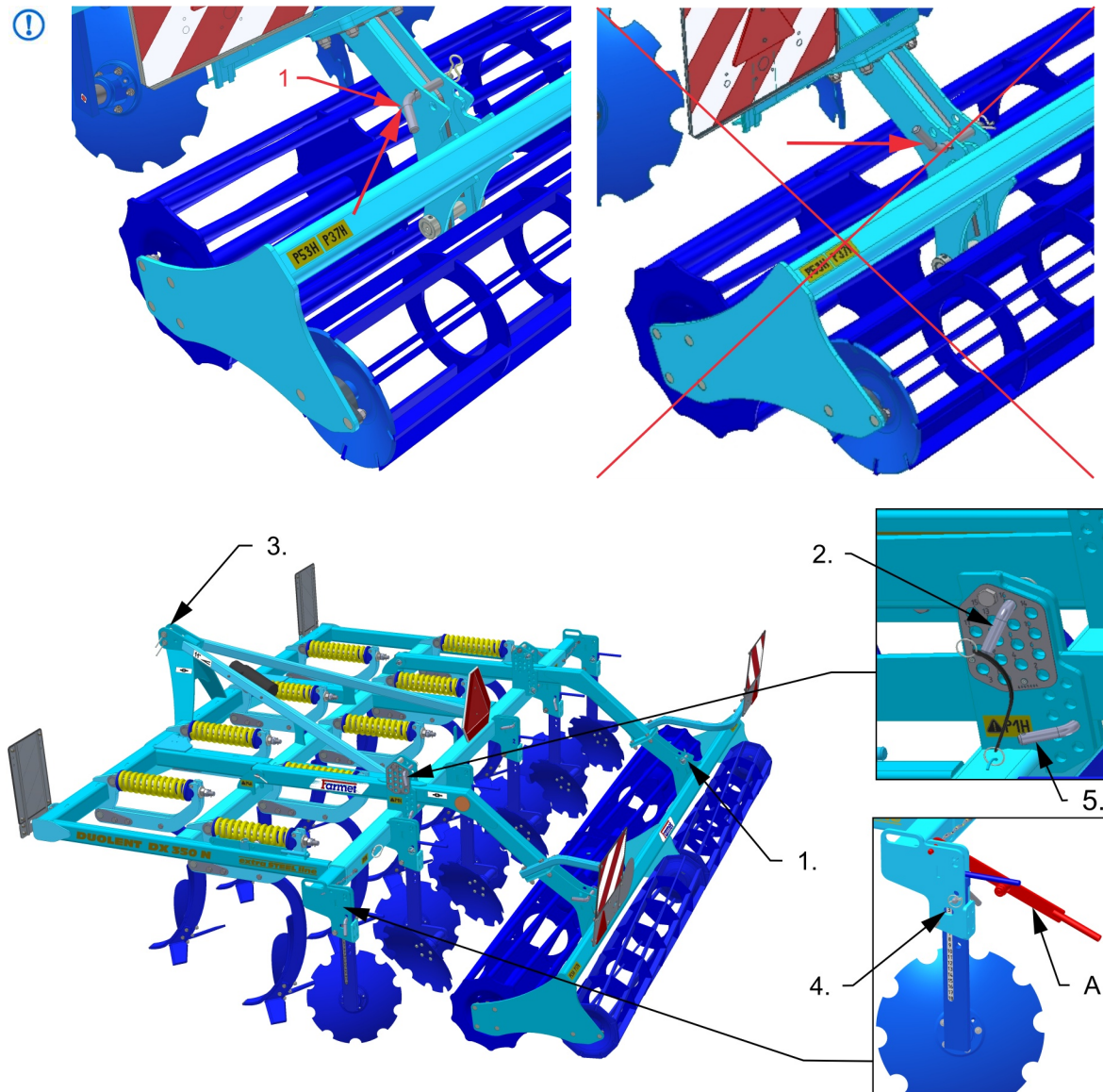

A – Auxiliary handle for disc setting

| Table of orientation depth of the machine <b>DUOLENT</b> |                             |               |                             |
|--|-----------------------------|---------------|-----------------------------|
| Setting scale  | Orientation depth (mm / in) | Setting scale | Orientation depth (mm / in) |
| 1  | 60 / 2,36                   | 9             | 204 / 8,03                  |
| 2  | 78 / 3,07                   | 10            | 222 / 8,74                  |
| 3  | 96 / 3,78                   | 11            | 240 / 9,45                  |
| 4  | 114 / 4,49                  | 12            | 258 / 10,16                 |
| 5  | 132 / 5,20                  | 13            | 276 / 10,87                 |
| 6  | 150 / 5,90                  | 14            | 294 / 11,57                 |
| 7  | 168 / 6,61                  | 15            | 312 / 12,28                 |
| 8  | 186 / 7,32                  | 16            | 330 / 13,00                 |



## 10.2 Share securing

- ⓘ The basic setting of the securing spring is performed by the manufacturer at  $395 \pm 5$  mm so it is horizontal.
- Regularly check the nut tightening of the lower and the upper pivot of the securing, tighten as needed.
- Regularly check the nut tightening of the securing rod.

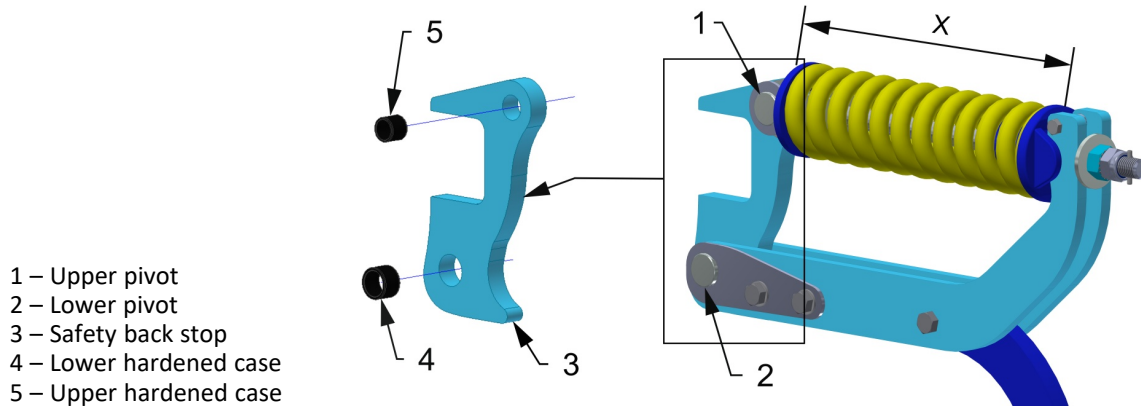

- 1 – Upper pivot
- 2 – Lower pivot
- 3 – Safety back stop
- 4 – Lower hardened case
- 5 – Upper hardened case

### SHARES

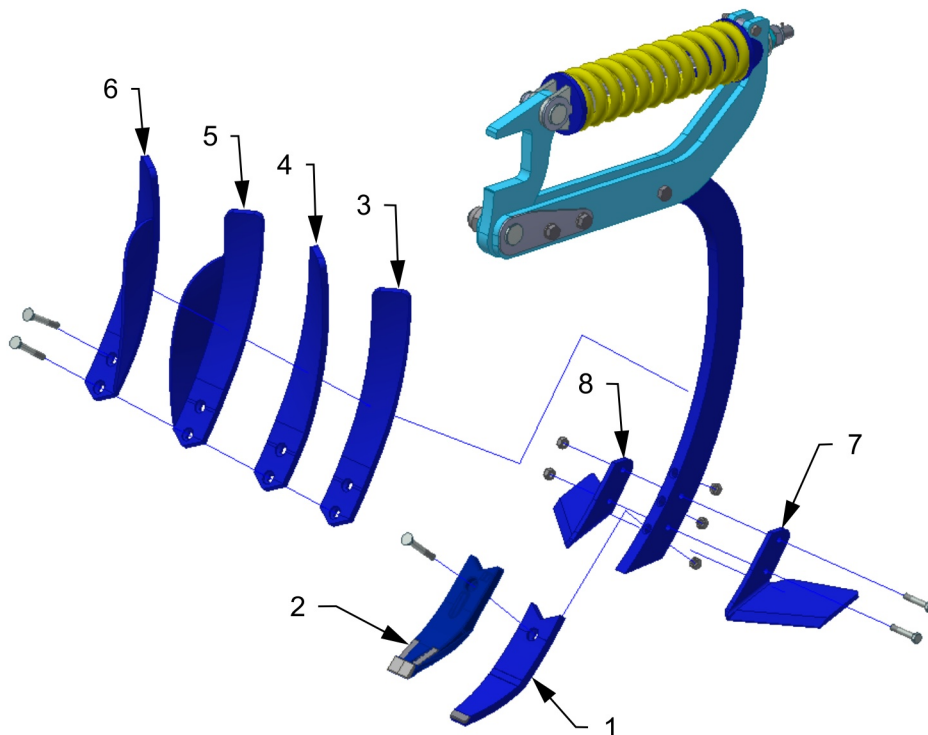

| Shares - nomenclature |                          |      |                                |
|-----------------------|--------------------------|------|--------------------------------|
| Pos.                  | Title                    | Pos. | Title                          |
| 1                     | Lower share SK           | 5    | Top right share with deflector |
| 2                     | Lower share MULTICARBIDE | 6    | Top left share with deflector  |
| 3                     | Top right share          | 7    | Left wing                      |
| 4                     | Top left share           | 8    | Right wing                     |

### 10.3 Placement of top left and right shares on the machine

**DX 210 N**

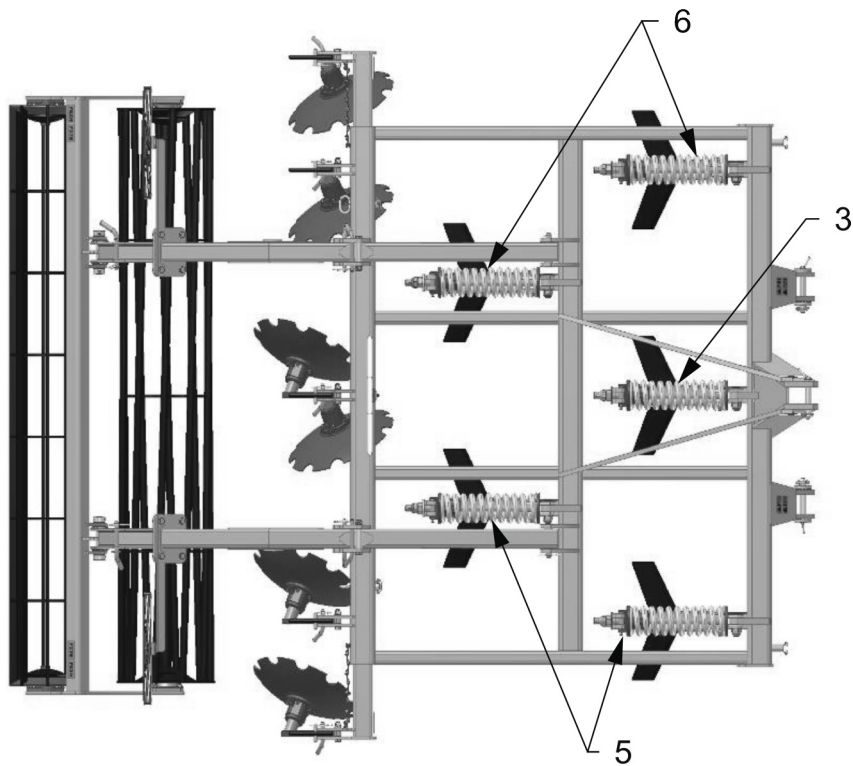

**DX 300 N**

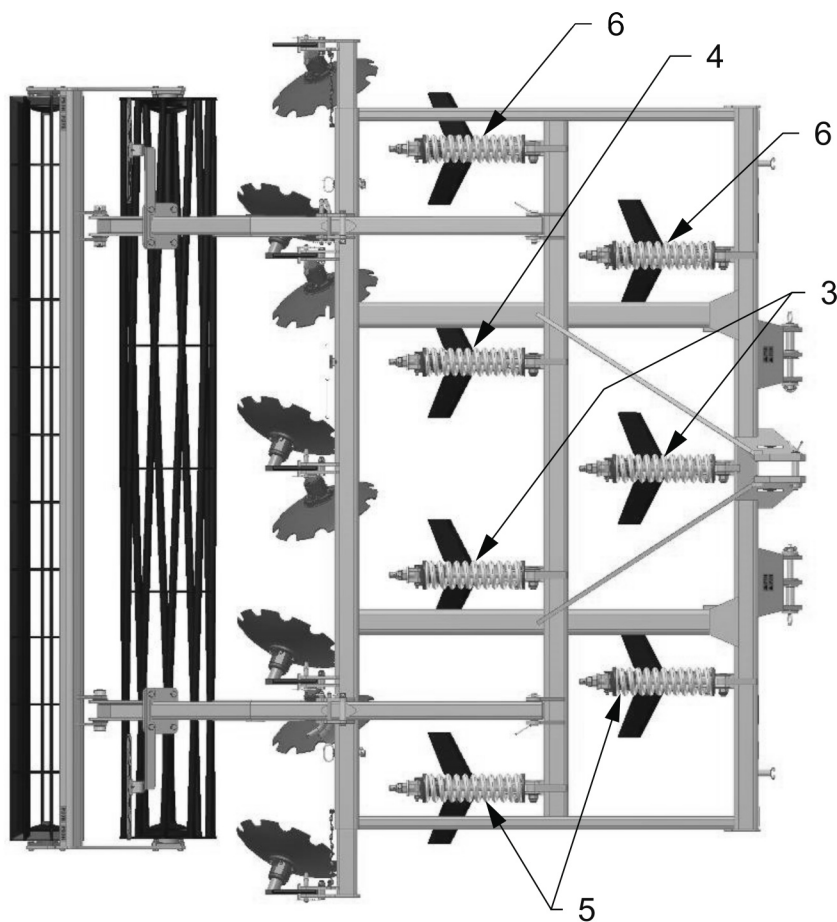

DX 350 N

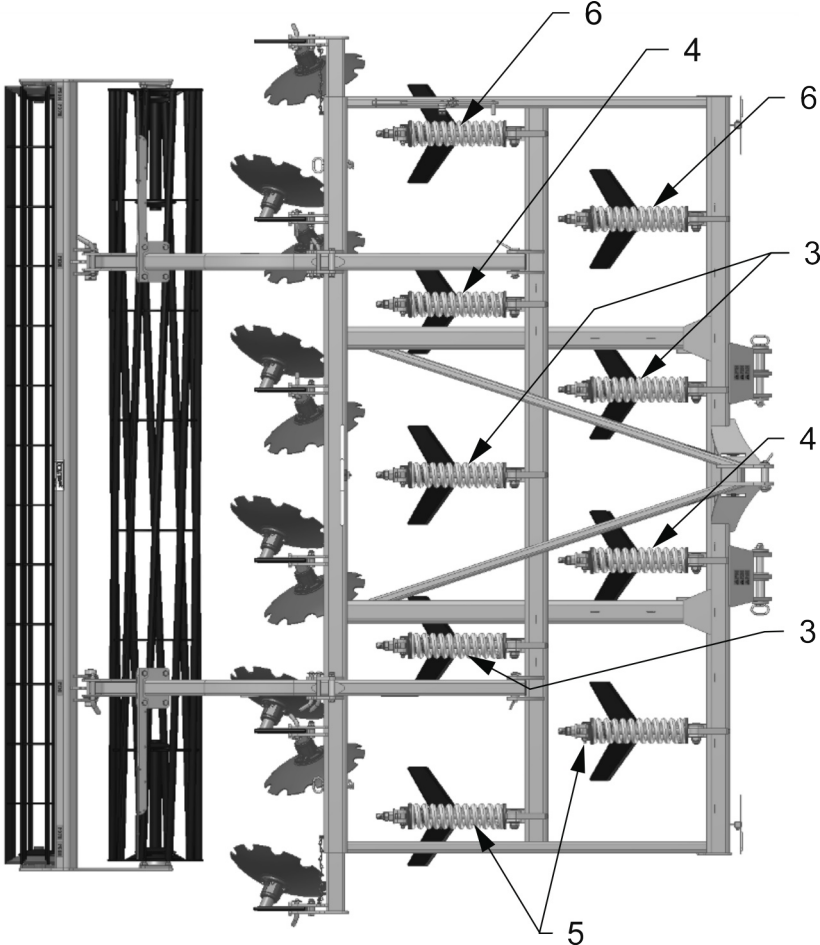

## 11 MACHINE MAINTENANCE AND REPAIRS



**Observe the safety instructions for treatment and maintenance.**

- If it is necessary to weld during the repair and have the machine connected to the tractor, it must have disconnected supply cables from the alternator and the accumulator.
- Check the tightening of all screw and other assembly connections at the machine before every use of the machine, furthermore continuously as needed.
- Continuously check the wear of the working bodies of the machine, possibly replace these worn working bodies with new ones.
- Adjustment, cleaning, and lubrication of the machine may only be performed with the machine at rest (i.e. the machine is standing and not working).
- Plants and other residues potentially caught on the shaft by the bearing have to be removed, otherwise the bearing will get damaged.
- When greasing the bearings, observe caution to prevent their damage.
- When working on a lifted machine, use suitable support equipment supported at marked points or at points suitable for that.
- During adjustment, cleaning, maintenance, and repair of the machine, you must secure those parts of the machine that could endanger the operator by falling or another movement.
- For catching the machine during handling using lifting equipment, use only the places marked with self-adhesive labels with the chain sign. —  —
- Upon a failure or damage of the machine, immediately turn off the tractor's engine and secure against restarting, secure the machine against movement — only then you can remove the failure.
- During repairs of the machine, use exclusively the genuine spare parts, suitable tools and protective equipment.
- Keep the machine clean.
- Lower the machine with caution so that the chisels and shares are not damaged by sharp lowering to the ground.



**Do not clean hydraulic cylinders and bearings with a high-pressure cleaner or direct water stream. The seals and bearings are not watertight at high pressure.**

## 12 MACHINE STORAGE

### Long-term machine shutdown:

- Store the machine under a roof if possible.
- Store the machine on a flat and solid surface with sufficient load capacity.
- Clean the machine before storing and conserve so that it is not damaged in any way during storage. Pay special attention to all marked lubrication points and properly lubricate them according to the lubrication plan.
- Lay by the machine in the transport position rested on the rear roller and frames. Place a suitable support under the frames (e.g. crossbar) so that the tips of the chisels are above the ground. If you do not have a suitable support, dismantle the chisels.

 **If you lay by the machine on the chisels, they might get damaged by the weight of the machine. The damage might also incur when you lay by the machine on an uneven surface for a short time when the weight of the machine transfers only to some chisels.**

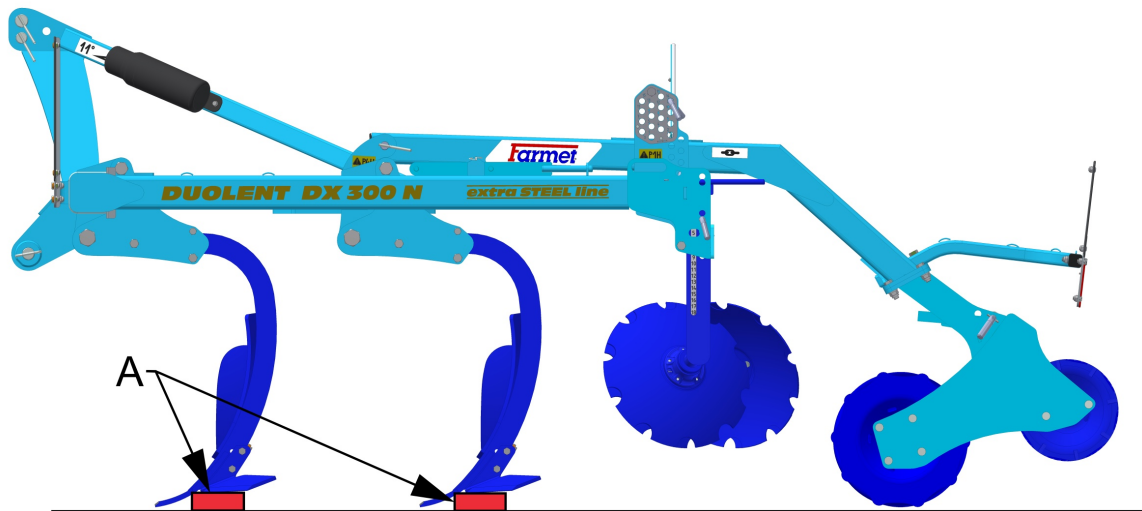

A - Sole piece



**Secure the machine against access of unauthorised persons.**

## 13 ENVIROMENTAL PROTECTION

- Handle oils and greases according to valid waste laws and regulations.

## 14 MACHINE DISPOSAL AFTER SERVICE LIFE EXPIRY

- The operator must ensure during machine disposal that steel parts and parts, in which hydraulic oil or lubricating grease moves are differentiated.
- Steel parts must be cut by the operator while observing safety regulations and handed over to the secondary raw material collection point. He must proceed with other parts according to valid laws about waste.

## 15 SERVICING AND WARRANTY CONDITIONS

### 15.1 Servicing

Servicing is secured by the dealer after consulting with the manufacturer, possibly directly by the manufacturer. Spare parts then using the sales network by individual sellers in the entire country. Use only the spare parts according to the spare parts catalogue officially issued by the manufacturer.

### 15.2 Warranty

1. The manufacturer provides a warranty of 24 months for these machine parts: main frame, axle, and machine tow bar. For other parts of the machine, the manufacturer provides a warranty of 12 months. The warranty is provided from the date of sale of the new machine to the end user (consumer).
2. The warranty applies to hidden defects that will show in the warranty period with proper use of the machine and while fulfilling the conditions stated in the operating manual.
3. The warranty does not apply to wearable spare parts, i. e. regular mechanical wear and tear of replaceable parts of the working sections (shares, edges, etc.).
4. The warranty does not apply to indirect consequences of possible damage, such as service life decrease etc.
5. The warranty is bound to the machine and is not void upon an owner change.
6. The warranty is limited to the disassembly and assembly, possibly replacement or repair of the defective part. The decision, whether to replace or repair the defective part, is up to the contractual workshop of Farmet.
7. During the warranty period, only the authorised servicing technician of the manufacturer may perform repairs or other interventions into the machine. In the opposite case, the warranty will not be acknowledged. This provision does not apply to the replacement of wearable spare parts (see point 3).
8. The warranty is conditioned by using the genuine spare parts of the manufacturer.



2009/004/03

(CZ) **ES PROHLÁŠENÍ O SHODĚ**  
 (GB) **CE CERTIFICATE OF CONFORMITY**  
 (D) **EG-KONFORMITÄTSERKLÄRUNG**  
 (F) **DÉCLARATION CE DE CONFORMITÉ**  
 (RU) **СЕРТИФИКАТ СООТВЕТСТВИЯ ЕС**  
 (PL) **DEKLARACJA ZGODNOŚCI WE**

1. (CZ) My (GB) We (D) Wir (F) Nous (RU) Мы (PL) My: **Farmet a.s.**  
 Jiřinková 276  
 552 03 Česká Skalice  
 Czech Republic  
 DIČ: CZ46504931  
 Tel/Fax: 00420 491 450136

(CZ) Vydáváme na vlastní zodpovědnost toto prohlášení. (GB) Hereby issue, on our responsibility, this Certificate. (D) Geben in alleiniger Verantwortung folgende Erklärung ab. (F) Publiions sous notre propre responsabilité la déclaration suivante. (RU) Под свою ответственность выдаем настоящий сертификат. (PL) Wydajemy na własną odpowiedzialność niniejszą Deklarację Zgodności.

2. (CZ) Strojní zařízení: - název : **Dlátový kypřič**  
 (GB) Machine: - name : **Chisel cultivator**  
 (D) Fabrikat: - Bezeichnung : **Meißelgrubber**  
 (F) Machinerie: - dénomination : **Cultivateur à siceaux**  
 (RU) Сельскохозяйственная машина: - наименование : **Чизельный культиватор**  
 (PL) Urządzenie maszynowe: - nazwa : **Spulchniarka dłutowa**
- typ, type : **DUOLENT**  
 - model, modèle : **DX 210 N**  
 - (CZ) výrobní číslo :   
 - (GB) serial number  
 - (D) Fabriknummer  
 - (F) n° de production  
 - (RU) заводской номер  
 - (PL) numer produkcyjny:

3. (CZ) Příslušná nařízení vlády: č.176/2008 Sb. (směrnice 2006/42/ES). (GB) Applicable Governmental Decrees and Orders: No.176/2008 Sb. (Directive 2006/42/ES). (D) Einschlägige Regierungsverordnungen (NV): Nr.176/2008 Slg. (Richtlinie 2006/42/ES). (F) Décrets respectifs du gouvernement: n°.176/2008 du Code (directive 2006/42/CE). (RU) Соответствующие постановления правительства: № 176/2008 Сб. (инструкция 2006/42/ES). (PL) Odpowiednie rozporządzenia rządowe: nr 176/2008 Dz.U. (Dyrektywa 2006/42/WE).

4. (CZ) Normy s nimiž byla posouzena shoda: (GB) Standards used for consideration of conformity: (D) Das Produkt wurde gefertigt in Übereinstimmung mit folgenden Normen: (F) Normes avec lesquelles la conformité a été évaluée: (RU) Нормы, на основании которых производилась сертификация: (PL) Normy, według których została przeprowadzona ocena: ČSN EN ISO 12100, ČSN EN ISO 4254-1.

(CZ) Schválil (GB) Approve by dne: 01.06.2012  
 (D) Bewilligen (F) Approuvé  
 (RU) Утвердил (PL) Uchwalili

p. Gavlas Dušan  
 technický ředitel  
 Technical director

  
**Farmet a.s.**  
 Jiřinková 276  
 552 03 Česká Skalice  
 DIČ CZ46504931  
 3P

V České Skalici dne: 01.06.2012

Ing. Karel Žďárský  
 generální ředitel společnosti  
 General Manager

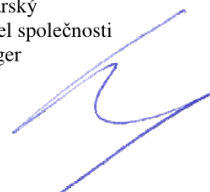

2009/005/03

(CZ) **ES PROHLÁŠENÍ O SHODĚ**  
 (GB) **CE CERTIFICATE OF CONFORMITY**  
 (D) **EG-KONFORMITÄTSERKLÄRUNG**  
 (F) **DÉCLARATION CE DE CONFORMITÉ**  
 (RU) **СЕРТИФИКАТ СООТВЕТСТВИЯ ЕС**  
 (PL) **DEKLARACJA ZGODNOŚCI WE**

1. (CZ) My (GB) We (D) Wir (F) Nous (RU) Мы (PL) My: **Farmet a.s.**  
 Jiřinková 276  
 552 03 Česká Skalice  
 Czech Republic  
 DIČ: CZ46504931  
 Tel/Fax: 00420 491 450136

(CZ) Vydávám na vlastní zodpovědnost toto prohlášení. (GB) Hereby issue, on our responsibility, this Certificate. (D) Geben in alleiniger Verantwortung folgende Erklärung ab. (F) Publiions sous notre propre responsabilité la déclaration suivante. (RU) Под свою ответственность выдаем настоящий сертификат. (PL) Wydajemy na własną odpowiedzialność niniejszą Deklarację Zgodności.

2. (CZ) Strojní zařízení: - název : **Dlátový kypřič**  
 (GB) Machine: - name : **Chisel cultivator**  
 (D) Fabrikat: - Bezeichnung : **Meißelgrubber**  
 (F) Machinerie: - dénomination : **Cultivateur à siceaux**  
 (RU) Сельскохозяйственная машина: - наименование : **Чизельный культиватор**  
 (PL) Urządzenie maszynowe: - nazwa : **Spulchniarka dłutowa**
- typ, type : **DUOLENT**  
 - model, modèle : **DX 300 N**  
 - (CZ) výrobní číslo :   
 - (GB) serial number  
 - (D) Fabriknummer  
 - (F) n° de production  
 - (RU) заводской номер  
 - (PL) numer produkcyjny:

3. (CZ) Příslušná nařízení vlády: č.176/2008 Sb. (směrnice 2006/42/ES). (GB) Applicable Governmental Decrees and Orders: No.176/2008 Sb. (Directive 2006/42/ES). (D) Einschlägige Regierungsverordnungen (NV): Nr.176/2008 Slg. (Richtlinie 2006/42/ES). (F) Décrets respectifs du gouvernement: n°.176/2008 du Code (directive 2006/42/CE). (RU) Соответствующие постановления правительства: № 176/2008 Сб. (инструкция 2006/42/ES). (PL) Odpowiednie rozporządzenia rządowe: nr 176/2008 Dz.U. (Dyrektywa 2006/42/WE).

4. (CZ) Normy s nimiž byla posouzena shoda: (GB) Standards used for consideration of conformity: (D) Das Produkt wurde gefertigt in Übereinstimmung mit folgenden Normen: (F) Normes avec lesquelles la conformité a été évaluée: (RU) Нормы, на основании которых производилась сертификация: (PL) Normy, według których została przeprowadzona ocena: ČSN EN ISO 12100, ČSN EN ISO 4254-1.

(CZ) Schwälil (GB) Approve by dne: 01.06.2012  
 (D) Bewilligen (F) Approuvé  
 (RU) Утвердил (PL) Uchwalil

p. Gavlas Dušan  
 technický ředitel  
 Technical director

  
**Farmet a.s.**  
 Jiřinková 276  
 552 03 Česká Skalice  
 DIČ CZ46504931  
 3R

V České Skalici dne: 01.06.2012

Ing. Karel Žďárský  
 generální ředitel společnosti  
 General Manager

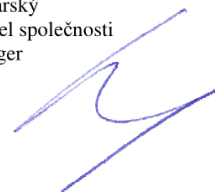

2010/003/02

(CZ) **ES PROHLÁŠENÍ O SHODĚ**  
 (GB) **CE CERTIFICATE OF CONFORMITY**  
 (D) **EG-KONFORMITÄTSERKLÄRUNG**  
 (F) **DÉCLARATION CE DE CONFORMITÉ**  
 (RU) **СЕРТИФИКАТ СООТВЕТСТВИЯ ЕС**  
 (PL) **DEKLARACJA ZGODNOŚCI WE**

1. (CZ) My (GB) We (D) Wir (F) Nous (RU) Мы (PL) My: **Farmet a.s.**  
 Jiřínková 276  
 552 03 Česká Skalice  
 Czech Republic  
 DIČ: CZ46504931  
 Tel/Fax: 00420 491 450136

(CZ) Vydáváme na vlastní zodpovědnost toto prohlášení. (GB) Hereby issue, on our responsibility, this Certificate. (D) Geben in alleiniger Verantwortung folgende Erklärung ab. (F) Publiions sous notre propre responsabilité la déclaration suivante. (RU) Под свою ответственность выдаем настоящий сертификат. (PL) Wydajemy na własną odpowiedzialność niniejszą Deklarację Zgodności.

2. (CZ) Strojní zařízení: - název : **Dlátový kypřič**  
 (GB) Machine: - name : **Chisel cultivator**  
 (D) Fabrikat: - Bezeichnung : **Meißelgrubber**  
 (F) Machinerie: - dénomination : **Cultivateur à siceaux**  
 (RU) Сельскохозяйственная машина: - наименование : **Чизельный культиватор**  
 (PL) Urządzenie maszynowe: - nazwa : **Spulchniarka dłutowa**
- typ, type : **DUOLENT**  
 - model, modèle : **DX 350 N**  
 - (CZ) výrobní číslo :   
 - (GB) serial number  
 - (D) Fabriknummer  
 - (F) n° de production  
 - (RU) заводской номер  
 - (PL) numer produkcyjny:

3. (CZ) Příslušná nařízení vlády: č.176/2008 Sb. (směrnice 2006/42/ES). (GB) Applicable Governmental Decrees and Orders: No.176/2008 Sb. (Directive 2006/42/ES). (D) Einschlägige Regierungsverordnungen (NV): Nr.176/2008 Slg. (Richtlinie 2006/42/ES). (F) Décrets respectifs du gouvernement: n°.176/2008 du Code (directive 2006/42/CE). (RU) Соответствующие постановления правительства: № 176/2008 Сб. (инструкция 2006/42/ES). (PL) Odpowiednie rozporządzenia rządowe: nr 176/2008 Dz.U. (Dyrektywa 2006/42/WE).

4. (CZ) Normy s nimiž byla posouzena shoda: (GB) Standards used for consideration of conformity: (D) Das Produkt wurde gefertigt in Übereinstimmung mit folgenden Normen: (F) Normes avec lesquelles la conformité a été évaluée: (RU) Нормы, на основании которых производилась сертификация: (PL) Normy, według których została przeprowadzona ocena: ČSN EN ISO 12100, ČSN EN ISO 4254-1.

(CZ) Schválil (GB) Approve by dne: 01.06.2012  
 (D) Bewilligen (F) Approuvé  
 (RU) Утвердил (PL) Uchwalil

p. Gavlas Dušan  
 technický ředitel  
 Technical director

  
**Farmet a.s.**  
 Jiřínková 276  
 552 03 Česká Skalice  
 DIČ CZ46504931  
 38

V České Skalici dne: 01.06.2012

Ing. Karel Žďárský  
 generální ředitel společnosti  
 General Manager

