

FALCON COMPACT



OPERATING INSTRUCTIONS

SN:2021/0096

VIN:

Edition : 8 / validity from 27.09.2021



Thank you for purchasing a Farmet machine. Thank you also for your trust, which is inspiring and binding for us.

Farmet a.s. is a dynamically developing Czech company engaged in the development, production, sale and service of agricultural machinery for tillage, fertilizer application and sowing, as well as technologies for the processing of oilseeds, vegetable oils and feed production.

The Farmet brand is focused on products of high quality and high utility value with use in productive agricultural and processing operations. Farmet is a partner of modern agriculture and food industry in many markets around the world.

Our own products and technologies are created in close cooperation between Farmet specialists and end customers, research institutions and universities, which is why our products often have unique technical solutions according to the requirements of agricultural practice.

Significant investments in development and modern production operations are a guarantee of further development in the field of quality and new productive production technologies. Our goal is to further increase the added value of products and strengthen their competitiveness in all markets, increase user comfort, occupational safety and environmental protection.



*Ing. Karel Žďárský
CEO and Chairman of the Board of Directors*



AGRICULTURAL MACHINES



OIL & FEED TECH





1 Machine configuration

Serial number of the machine	2021/0096
VIN	
Machine code	T3/150/FD/DS/IB/EHC/1V7/1V250/1V500/TL2/SF26/BM/MT/WL/S1/T8
HW ECU	03.03.00.00
SW ECU	02.04.19.00

Machine equipment	
<input checked="" type="checkbox"/>	V1 small fan
<input type="checkbox"/>	Type of seed tube distributions – EC
<input type="checkbox"/>	Type of seed tube distributions – HM
<input type="checkbox"/>	Terminal Basic
<input checked="" type="checkbox"/>	Terminal Touch 800
<input type="checkbox"/>	Terminal Touch 1200
<input type="checkbox"/>	Licence Track Leader
<input type="checkbox"/>	Licence Section control
<input type="checkbox"/>	Licence Multi control
<input type="checkbox"/>	Licence Tramline management
<input type="checkbox"/>	Licence ISOBUS-TC

The serial number of the machine is printed on the serial plate and on the machine frame. This machine serial number must always be stated when ordering service or spare parts. The type plate is located on the front of the hopper.

FARMET a.s. S2a e8*167/2013*????*?? FAR??????????????? 0 kg A-0: 0 kg A-1: 0 kg A-2: ----- kg A-3: ----- kg		 Jiřínková 276 552 03 Česká Skalice MADE IN CZECH REPUBLIC	
FALCON FA???		ROK/ YEAR	2020
CELK. HMOTNOST/ TOTAL WEIGHT		0 kg	
kg	T-1	T-2	T-3
B-1	---	---	---
B-2	---	---	---
B-3	---	---	---
B-4	---	---	---
			
			
		www.farmet.cz	

Content

1	MACHINE CONFIGURATION	3
2	QUICK START	7
3	TECHNICAL PARAMETERS	8
4	GENERAL INSTRUCTIONS FOR USE	10
4.1	SAFETY TOOLS	11
5	TRANSPORTING MACHINE BY MEANS OF TRANSPORT	11
6	HANDLING THE MACHINE WITH TRANSPORT EQUIPMENT	11
7	TRANSPORT OF THE MACHINE ON PUBLIC ROADS	12
8	WORKING SAFETY LABELS	13
9	MACHINE DESCRIPTION	15
10	PUTTING THE MACHINE INTO OPERATION	16
10.1	AGGREGATION OF A MACHINE WITH A TRACTOR	16
10.2	MACHINE HYDRAULICS CONNECTION	17
10.3	HYDRAULIC DIAGRAM OF THE MACHINE	18
10.4	CONNECTION OF THE ELECTRONIC PART OF THE MACHINE.....	19
10.4.1	<i>Connection to tractor battery + Müller terminal</i>	19
10.4.2	<i>Connecting the machine via the ISOBUS socket of the tractor + Müller terminal</i>	21
10.4.3	<i>Connecting the machine via the tractor's ISOBUS socket + Tractor terminal</i>	22
10.4.4	<i>Selecting and setting up the virtual terminal (VT) and task manager (TC)</i>	23
11	MACHINE FAN	24
11.1	FAN WITH SEPARATE DRIVE ON PTO	26
11.2	FAN SPEED SETTING ACCORDING TO SEED	27
12	SEED SWITCHING SENSORS	28
12.1	SOWING SWITCHING	28
12.2	SOWING OFF	28
13	ELECTRONIC MACHINE CONTROL MÜLLER ELECTRONIC	29
13.1	WORK SCREEN.....	29
13.2	INFORMATION	30
13.3	CREATING A TASK WITH A COMPUTER	30
13.4	REMAINING CALCULATED AMOUNT IN THE HOPPER	31
13.5	GPS SETTINGS FOR MACHINES WHEN UNFOLDING IN THE HALL	32
13.6	CONTROL AND SETTINGS OF THE MARKERS	33
13.6.1	<i>Settings of aggressivity of the markers</i>	34
13.6.2	<i>The markers control</i>	35
13.6.3	<i>Obstacle function</i>	36
13.6.4	<i>Swamp function</i>	36
13.7	ENTER THE HOPPER FILL	37
13.8	USER PRODUCT DATABASE	38
13.9	ASSIGNMENT OF THE MOTOR TO THE GIVEN HOPPER	39
13.10	ACTIVATION / DEACTIVATION DISPENSER	40
13.11	SEED FLOW SENSING DICKEY-JOHN-DEACTIVATION	41
14	RAIL LINES	42
14.1	RAIL LINES SET ON AND OFF	42
14.2	STEPS FOR SETTING THE TRAMLIN RHYTHM CORRECTLY	43
14.2.1	<i>Even tramline rhythms</i>	44
14.2.2	<i>Odd rhythms of tramlines</i>	47

14.2.3	<i>Special tramline rhythms</i>	48
14.3	THE MOST FREQUENTLY USED TRAMLINE SETTINGS	51
14.4	RAIL LINE VALVES	52
14.5	AIR PRESSURE REDUCING VALVE OF THE TRAMLINES	53
14.6	TRAMLINE MARKERS	54
15	FARMET DISPENSER	55
15.1	DISPENSER FUNCTION TEST.....	56
15.2	ROUGH SEEDS.....	56
15.3	ROLLER REPLACEMENT	57
15.4	ROLLERS FOR FINE SEEDS.....	58
16	SOWING TEST	59
16.1	HOSE DISTRIBUTION TYPE.....	59
16.2	SOWING TEST	60
16.3	SOWING TABLES FOR FARMET DISPENSER.....	62
17	SETTINGS OF SEED SECTION	64
17.1	SOWING DEPTH SETTING	64
17.1.1	<i>Recommended depth</i>	65
17.2	SOWING SECTION PRESSURE SETTING	66
17.2.1	<i>Increase the pressure</i>	67
17.2.2	<i>Lowering the pressure</i>	67
17.3	SEED COULTERS	68
17.3.1	<i>Disc and pressure wheel trowels</i>	69
17.3.2	<i>Pressure wheel</i>	70
17.3.3	<i>Harrows</i>	71
18	ADJUSTIN THE DOSE DURING WORK	72
19	EMPTYING THE HOPPER USING ELECTRONICS	73
20	WORKING POSITION SOURCE	74
21	SOURCE SPEED MACHINERY	75
22	MACHINE GEOMETRY	76
23	MACHINE LIGHTING	77
24	CONTROLLING SECTIONS MANUALLY (SECTION CONTROL)	78
25	ADJUSTING THE HARROW BEHIND THE ROLLER	79
26	ADJUSTING THE DEPTH OF THE FRONT PREPARATION SECTION	80
26.1	SIDE DEFLECTORS OF THE FRONT PREPARATION SECTION.....	81
26.2	TRACTOR TRACK CULTIVATORS	81
26.3	FLEXIBOARD	82
27	SOWING SECTION SHIFT	83
28	HANGING THE MACHINE ON A CRANE	85
29	ERROR MESSAGES	86
29.1	ISO MESSAGES	86
29.2	REGULATIONS ALARMS	88
29.3	MACHINE-SPECIFIC ALARMS	90
30	MACHINE MAINTENANCE AND REPAIRS	94
30.1	MAINTENANCE PLAN.....	95
30.1.1	<i>Lubricant nadling</i>	98
30.1.2	<i>Tire pressure</i>	99
30.1.3	<i>Recommended tightening torques</i>	99

31	SHUTTING DOWN THE MACHINE.....	100
32	ENVIRONMENTAL PROTECTION	100
33	END OF LIFE MACHINE DISPOSAL	100
34	SERVICE AND WARRANTY CONDITIONS	100
34.1	SERVICE FAVOR	100
34.2	GUARANTEE	100

2 Quick start

Point	Act	Page
0	Safety notice.	10
1	Engage the Falcon with towing equipment.	16
2	Connect all hydraulic hoses, including the return drain.	17
3	Connect the 7-pin cable of the machine's road lights.	
4	Connect the machine electronics to the towing of vehicle .	19
5	Raise the front support leg of the machine and secure.	
6	Open the front preparation section lift valve.(yellow marker)	80
7	Switch on the seed drill terminal with main switch. 	
8	Check that the seed drill is clean.	55
9	Check the squeegee for leaks in the seed drill.	55
10	Check the permeability of the seed hoses.	
11	Sprinkle the seed.	37
12	Adjust the machine plane and lock the tractor arms.	
13	Adjust the sowing depth.	64
14	Set the pressure on the pressure reducing valve.	67
15	Depth adjustment of the front preparation section.	80
16	Perform a seed test.	60
17	Set the priority on the hydraulic circle of the fan.	17
18	Set the required oil flow for the fertilizer hydraulic motor.	17
19	Set the fan speed according to the seed and the rate.	27
20	Set the required hydraulic functions – markers, tramline markers, etc.	35

3 Technical parameters

Parameters		FALCON 3	FALCON 4
Working width (mm)		3000	4 000
Transport width (mm)		3 000	4 000
Transport height (mm)		2 800	2 800
Total length of the machine (mm)		7 000	7 000
Working depth (mm)		0–100	0–100
Hopper capacity (mm)		3 000	3 000
Filling height of the hopper (mm)		2 600	2 600
Filling hole size (mm)		1920x520	1920x520
Number of seeding coulters (spacing 125 / 150 mm)		24 / 20	32 / 26
Seed coulters pressure (kg)		50–120	50–120
Disc diameter of the double disc coulters		355	355
Number of preparation section disks Ø490	Front row	12	16
	Back row	11	15
Number of chisels 3-row section depth 80 mm (spacing 100 mm)		12/10	16 / 13
Number of chisels 3-row section depth 200 mm (spacing 250 / 300 mm)		12/10	16 / 13
Work performance (ha/h)		3 - 4,5	4–6
Towing device (kW/HP) *		88 / 120	103 / 140
Working speed (km/h)		10–20	10–20
Maximum transport speed (km/h)		25	25
Maximum slope accessibility (°)		6	6
Tire size		405/70 R20 420/65 R20	405/70 R20 420/65 R20
Brake type / distribution***		air / double hose	air / double hose
Required pressure for brake control (kPa) ***		8,5	8,5

Parameter	FALCON 3	FALCON 4
Number of hydraulic circuits / pressure (bar) ****	1-4 / 200	1-4 / 200
Type of quick couplings	ISO 12,5	ISO 12,5
Return waste flow (max. 5 bar)	ISO 20	ISO 20
Hydraulic fan oil flow (l/min)	30-40	30-40
Oil flow for machine control (l/min)	30	30
Electrical system requirement	12 V DC / 40 A	12 V DC / 40 A
Tractor hitch requirement	TBZ cat. 3	TBZ cat. 3
Machine weight (kg)	3 800	4 400



Transport/Brake system: Observe the national regulations applicable to the transport of machines on public roads. Check the legal regulations in force in the country and the regulations on the maximum permissible gross weights and axle loads, as well as on the necessary use of the brake system. If you have further questions, please contact our sale representative.

4 General instructions for use

1. ^(x) The machine is manufactured in accordance with the latest state of technology and approved safety regulations. Even that, there is a risk of injury to the user or third parties or damage to the machine or other property damage.
2. ^(xx) Use the machine only in harmless condition, in accordance with its intended use, with knowledge, with knowledge of possible dangers and in compliance with the safety instructions in these operating instructions. The manufacturer is not responsible for damage caused by using the machine in violation of the machine's limit parameters and the instructions for using the machine. The risk is born by user.

Immediately remove defects, that can negatively effect safety risk.



WARNING – This warning sign must be in the immediate danger of a dangerous situation, ending with serious injury or death.



ATTENTION – This warning sign alerts you to a situation that could result in minor or minor injury. It also alerts you to dangerous actions associated with activities that could damage the machine.



NOTICE– This warning sign indicates a technical recommendation.



RECOMMENDATION .



PRESS.

3. The machine may be operated by a person authorized by the operator under the following conditions:
 - Must have a valid driving license of the relevant category.
 - They must be demonstrably acquainted with the safety regulations for working with the machine.
 - He must be familiar with the machine instructions and the machine operator.
 - They must know the meaning of the safety signs placed on the machine. Respecting them is important for safe and reliable operation of the machine.
4. Maintenance and service repairs on the machine may only be performed by a person:
 - Authorized by the operator.
 - Demonstrably acquainted with the safety regulations for working with the machine.
 - When repairing a machine attached to tractor has to have the right category of driver license.
5. The operator of the machine must be sure of other persons safety when working with the machine or transporting the machine.
6. When transporting the machine or working on the field the machine operator have to control the machine from inside the cabin.

7. The machine operator can only enter the machine structure only at standstill position and when the machine is blocked from movement for the following reasons:
 - Adjustments of working parts of the machine,
 - Repair and maintenance of the machine,
 - Unlock or secure the axle ball valves,
 - Securing the axle ball valves before lowering the side frames,
 - Adjustment working parts of the machine after folding side frames.
8. ^(xxx) When climbing on the machine don't step on tires of the pneumatic roller or other spinning parts. They can spin and you can fall and have serious injuries.
9. However, the changes are, or adjustments on the machine can be done only with written agreement of the manufacturer. The manufacturer is not responsible for any damage resulting from non-compliance with this instruction. The machine must be maintained with the prescribed accessories, equipment and facilities, including safety markings. All warning and safety signs must be legible at all times and in place. In case of damage or loss the marks must be immediately renewed.
10. When working with machine the operator must have the Manual of using with requirements of safety work available.

11. The operator cannot using the alcohol when working with machine, or pills, or narcotics and hallucinating substances, which they increased lower attention and coordinated abilities. If the operator must consume a pills prescribed by a doctor or consuming free pills for sale must be informed by a doctor that in these circumstances is capable to work responsibly and safely operate the machine.

4.1 Safety tools

For operation and maintenance:

- Tight-fitting clothes
- Safety gloves and safety glasses for dust protection and sharp parts of the machine.



5 Transporting machine by means of transport

1. The means of transport designed to transport of the machine must have a load of capacity at least equal to the weight of the transported machine. The total weight of the machine is listed on the nameplate.
2. The dimensions of the transported machine including the means of transport must meet with the valid regulations for operation on roads (decrees, laws).
3. The transported machine must always be attached to the vehicle in such a way that it cannot be released spontaneously.
4. The carrier is responsible for damage causes of an incorrectly or insufficiently attached machine to the vehicle.

6 Handling the machine with transport equipment

1. Lifting equipment and binding instruments using for manipulation with the machine must have its own load capacity minimum equal with weight of the machine being handled.
2. Attachment of the machine for manipulation may only be carried out in places designed for this purpose and marked with self-adhesive labels showing the „chain”. 
3. After attachment (suspension) in places designated for this purpose, it is forbidden to move in the area of possible reach of the manipulated machine.

7 Transport of the machine on public roads

- The machine attached to the rear arms of tractor (TBZ 3).
- The side frames must be folded down to a vertical position and secured.
- The machine must be equipped by removable rails with markable contours, functional lightnings and rear marking plate for slow vehicle (according to EHK NO.69).
- The lightning must be on public roads ready to operate.
- A tractor must be equipped by a special lightning system of orange colour, which must operate on public roads and be put into operation.
- The operator with respect on the measurements of the machine have to be careful and considered on the others drivers on the public roads.
- The operator must be sure to secure rear arms TBZ of the tractor and put them in secure position when transporting the machine on public roads. At the same time the arms of the rear TBZ tractor must be secured against lateral swing.



- **It is strictly forbidden to transport people or cargo on the machine or to attach other machine, trailer or attachments to the machine.**
- Maximum transport speed limit on public roads is **30 km/hour**.
- **Prohibition of operation in reduced visibility!**



The machine can be operated on roads only if it is equipped with air brakes (the customer will receive a technical certificate). Otherwise, the machine must not be operated on public roads!

8 Working safety labels

Safety warning labels are used to protect operator.





In general:



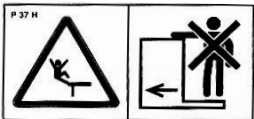
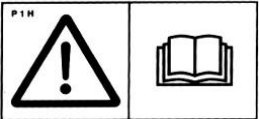

1. Strictly observe the safety warning labels.
2. All safety instructions also apply to other users.
3. If the **Safety label** on the machine is damaged or destroyed, the **OPERATOR MUST REPLACE THIS LABEL WITH A NEW!**

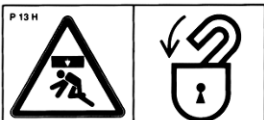

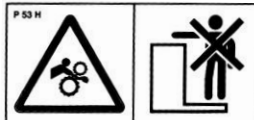
The position, appearance and the exact meaning of the occupational safety labels on the machine are determined in the following tables.

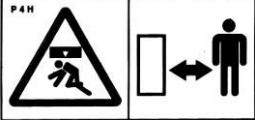
Table 2 – self-adhesive safety warning labels are located on the machine.

Positions on the machine	Safety label	Meaning of labels	Label stickers
1		Before the manipulation with the machine ready the instructions for using. When operating, follow the instructions and safety regulations for operating the machine.	P 1 H
2		Driving and transporting the machine structure is strictly forbidden.	P 37 H
3		When connecting or disconnecting do not enter between the tractor and the machine nor enter this area unless the tractor and machine are stationary and the engine is switched off.	P 2 H
4		Stay out of the reach of the tractor – agricultural implement when the tractor engine is running.	P 6 H
5		Before beginning of the transporting secure the axle against unexpected drop.	P 13 H
6		Secure the machine against unexpected movement.	P 52 H
7		Do not be close to the rotating parts, unless these are not in calm position that means that they are not rotating.	P 53 H

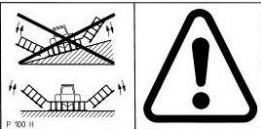
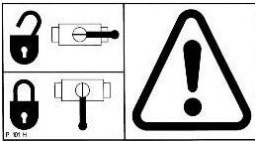
8		Stay out from the raised machine reach.	P 4 H
9		When folding and unfolding the side frames and the service platform, stay out of their reach.	P 50 H
10		Stay out of reach when unfolding the service platform.	P 20 H
11		Keep safe distance from electrical equipment when working or transporting the machine.	P 39 H
12		It is forbidden to fold and unfold the side frames of the machine on a slope or on sloping surface.	P 100 H
13		Shown lever positions and functions of the hydraulic ball valve located on the piston rod.	P 101 H

- Position of the safety labels on the machine:

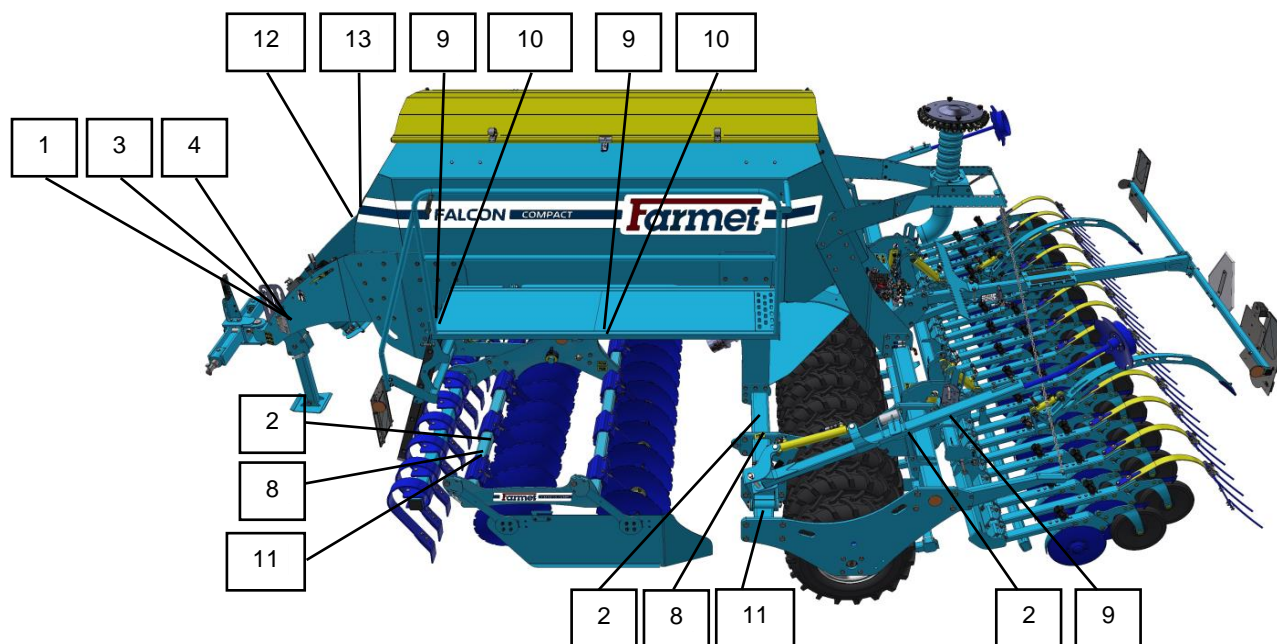

9 Machine description

- FALCON PRO is structurally designed as a modular seed machine, with a rich amount of equipment.

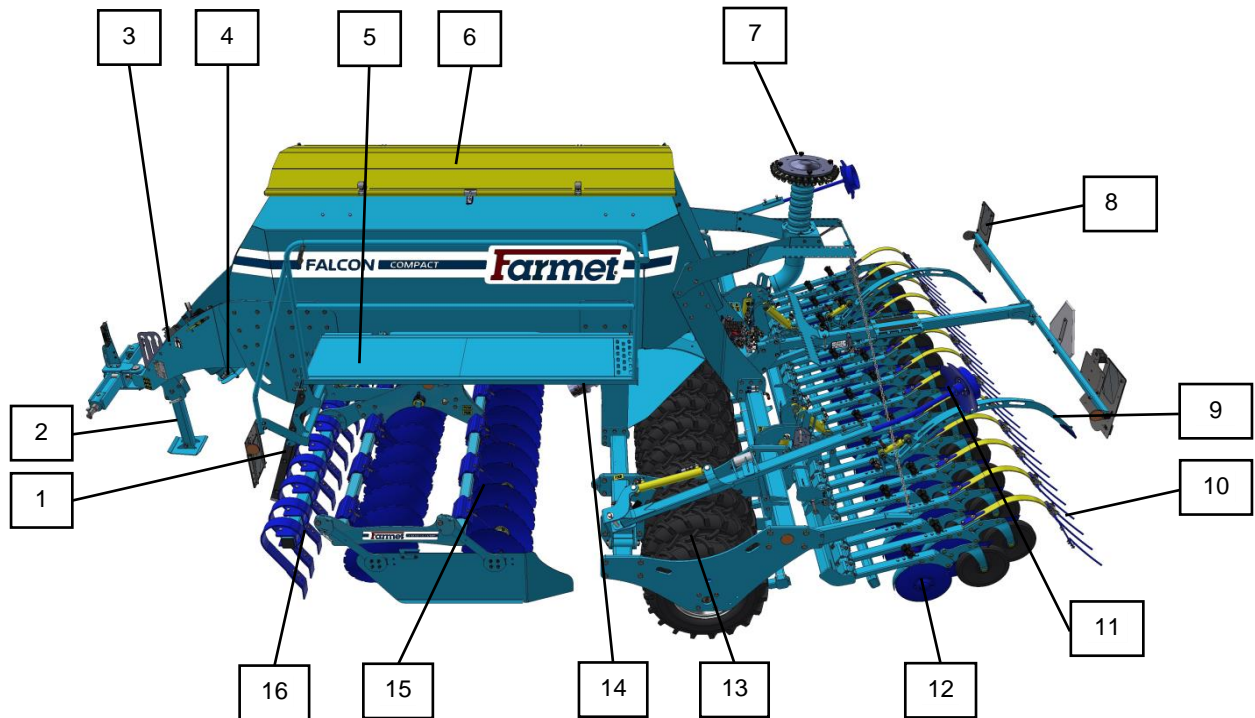

1	Access ladder	9	Tramline markers
2	Folding supporting leg	10	Harrow pens behind the seed coulters
3	Drawbar	11	Marker
4	Fan	12	Seeders with pressure wheel
5	Service platform	13	Pneumatic flotation rammer
6	Seed hopper	14	Dispenser with mixer
7	Distributor head number 1 (for dispenser 1)	15	Exchange preparatory section
8	Targets with road lighting	16	Flexi board

10 Putting the machine into operation

- Before taking over the machine, check and control that it has not been damaged during transport and that all the parts contained in the delivery note have been delivered.
- Before putting the machine into operation read these operating instructions carefully. Before using the machine for the first time be familiar with yourself with controls and overall instructions.
- The machine showing signs of damage must not be put into operation.
- The operator is responsible for safety and for all damages caused by operation of the tractor and the connected machine.
- The machine may only be connected to a tractor whose curb weight is equal to or higher than the total weight of the connected machine.

10.1 Aggregation of a machine with a tractor











Tractor engine power requirement for the machine FALCON 3		90 kW*
Tractor engine power requirement for the machine FALCON 4		117 kW*
Requirement for TBZ tractor	Spacing of lower suspension joints (measured on joint axels)	1010±1,5 mm, (can also be set 910±1,5 mm)
	∅ Holes for lower suspension joints for machine suspension pins	∅37,5 mm
Tractor hydraulic system requirement	Electrical distributor circuit	Circuit pressure min.190 bar – max.230 bar 60 l/min., 2 pcs of quick coupling sockets ISO 12,5
	Hydraulic drive circuit	Pressure in the filling branch min.130 bar–max.230 bar, 1 pc of quick coupler socket ISO 12,5
		Pressure in the waste branch max.5 bar, 1pc of quick coupler socket ISO 20
	Seed pressure	Circuit pressure min.190 bar – max.230
	Lifting and lowering circuit of the preparation section	Circuit pressure min.190 bar – max.230 40 l/min., 2pcs of quick coupling sockets ISO 12,5
Tractor air system requirement (if the machine is equipped with brakes)	Machine axle braking circuit	Circuit pressure min.6 bar – max. 15 bar
Tractor electrical system requirement	Connection of the electronic system of the machine	12 V / 40 A
		+ red - black



No persons may be present in the are between tractor and the machine during connecting.

10.2 Machine hydraulics connection

- Only connect the hydraulic hoses of the machine when the hydraulic circuits of the machine and the tractor (unit) are depressurized.
- The hydraulic system is under high pressure.
- Regularly check all lines, hoses and fittings for leaks and obvious damage. Eliminate any defects immediately.
- When searching for and removing leaks, use only suitable aids, protective goggles and gloves are the basis.
- Use the plugs (on the machine) and sockets (on the tractor) of quick couplings of the same type to connect the machine hydraulic system to the tractor. Connect the quick couplings of the machine to the hydraulic circuits of the tractor according to the table below.

Circle	Plug	Circuit color	Function	Oil flow l/min	Constant flow
Return waste branch	ISO 20		Free fall	0	
Hydraulic switchboard	ISO 12,5		Pressure	MAX	
	ISO 12,5		Reverse	MAX	
Preparation section	ISO 12,5		Pressure	20-40	
	ISO 12,5		Reverse	20-40	
Flexi board	ISO 12,5		Pressure	15-20	
	ISO 12,5		Reverse	15-20	
Fan	ISO 12,5		Pressure	20-40	
Microdrill	ISO 12,5		Pressure	15-20	



To prevent involuntary or any stranger mistaken hydraulics movement, the control cabinets on the tractor must be secured or locked when not in use or in the transport position.



It is forbidden to disassemble parts of the machine hydraulic system that are under pressure. Hydraulic oil that penetrates the skin under high pressure causes of injury, seek medical advice immediately.

10.3 Hydraulic diagram of the machine

Markers

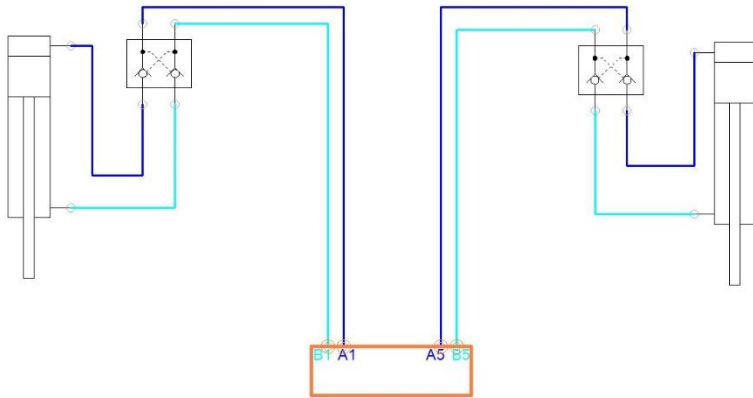

Tramline markers

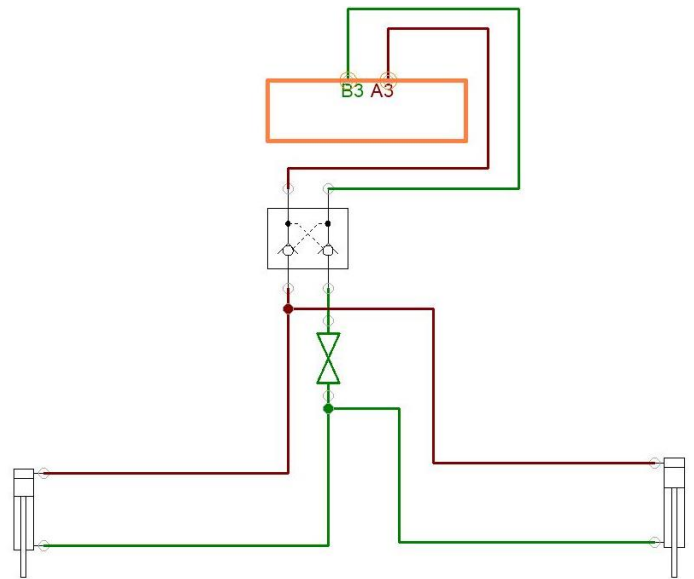

Folding / Tipping machine

Preparation section + Fertilization

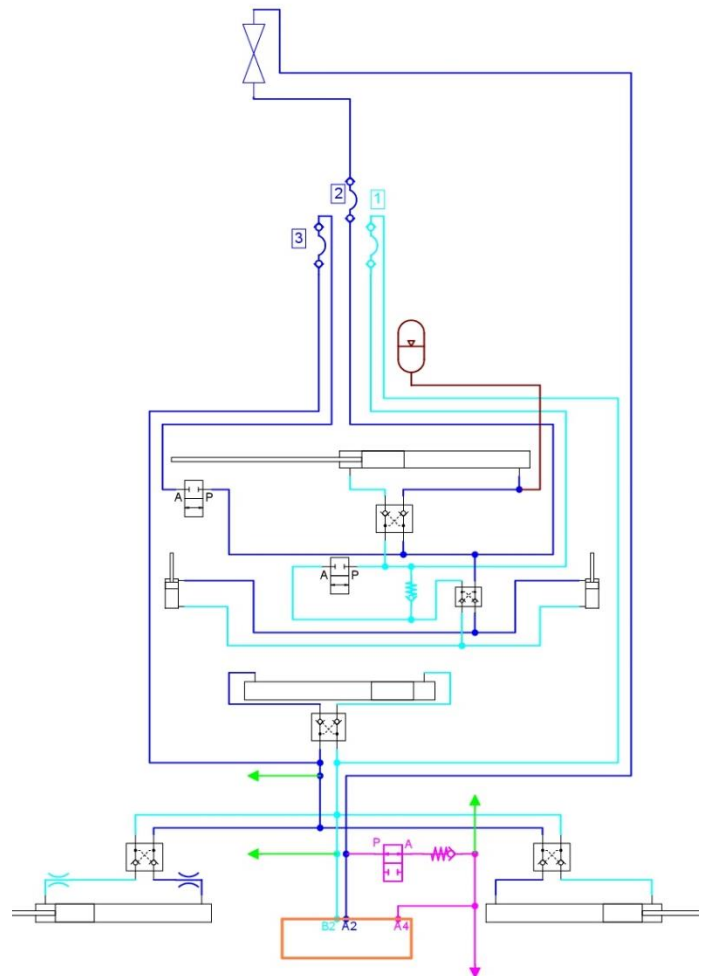
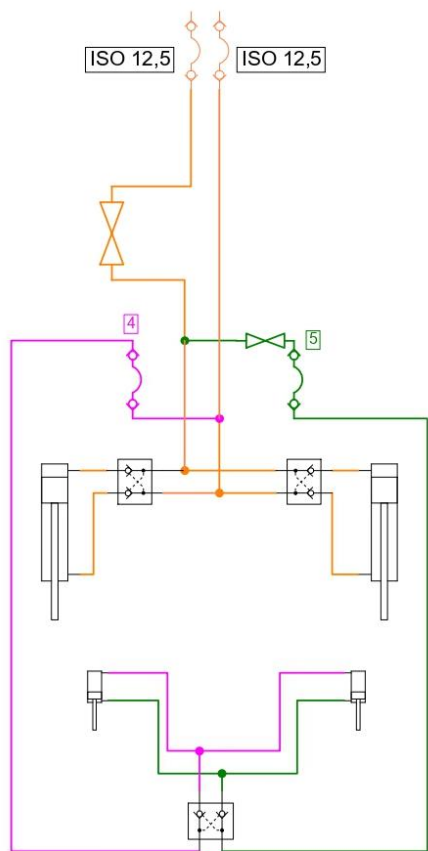

10.4 Connection of the electronic part of the machine

- 1) Connection to the tractor battery + Müller terminal (10.4.1)
- 2) Machine connection via ISOBUS tractor socket + Müller terminal (10.4.2)
- 3) Machine connection via ISOBUS tractor socket + Tractor terminal (10.4.3)

10.4.1 Connection to tractor battery + Müller terminal

- The electronic unit of the machine only connect when the tractor is at standstill, secured against movement and against the intervention of strangers.
- Use the power cord supplied with the machine to connect the electronic unit. The connecting cable must be connected directly to the tractor battery!
- Place the terminal in the tractor in a place where it will not obstruct the driver's view and at the same time be in the operator's field of vision.
- Secure the wiring securely to prevent mechanical or thermal damage.
- To connection cable set contains a voltage relay, which is switched by a cable that is ideally attached to the ignition of the tractor, or to 12 V switched. This relay switches the communication between the machine control unit and the terminal.
- If welding is required on the machine or tractor disconnect the unit from the power supply and disconnect the connecting cables.
- Never replace the fuse with another object and always replace it with a fuse with the same fuse when replacing it.

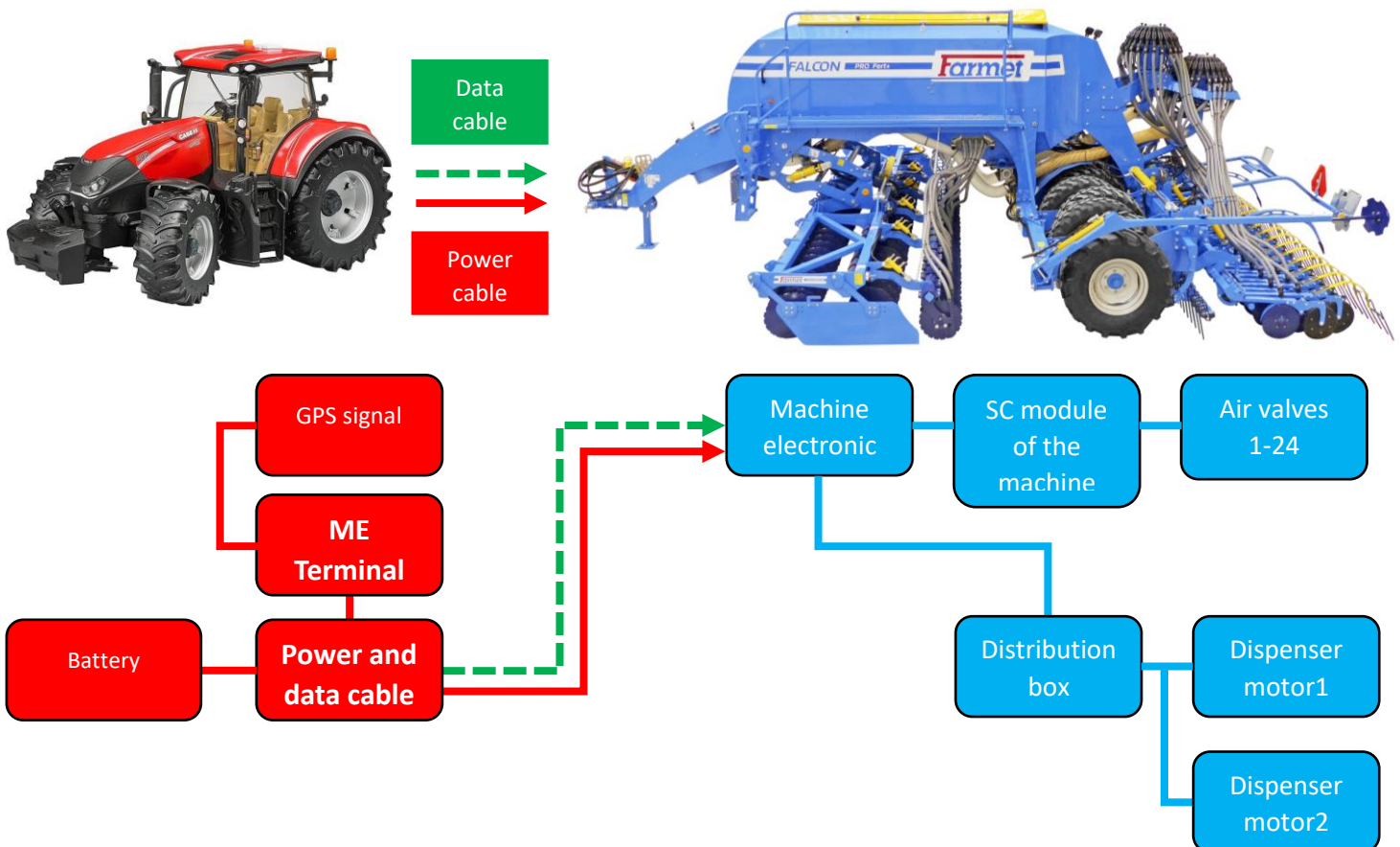

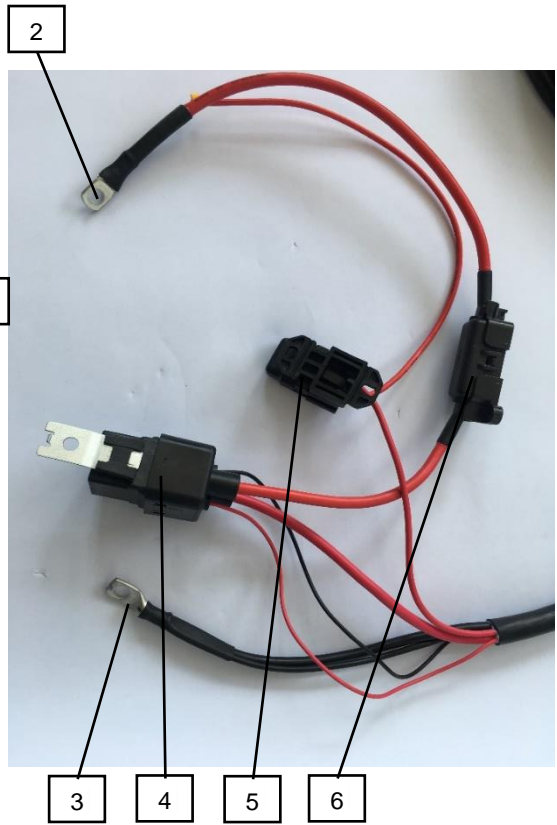
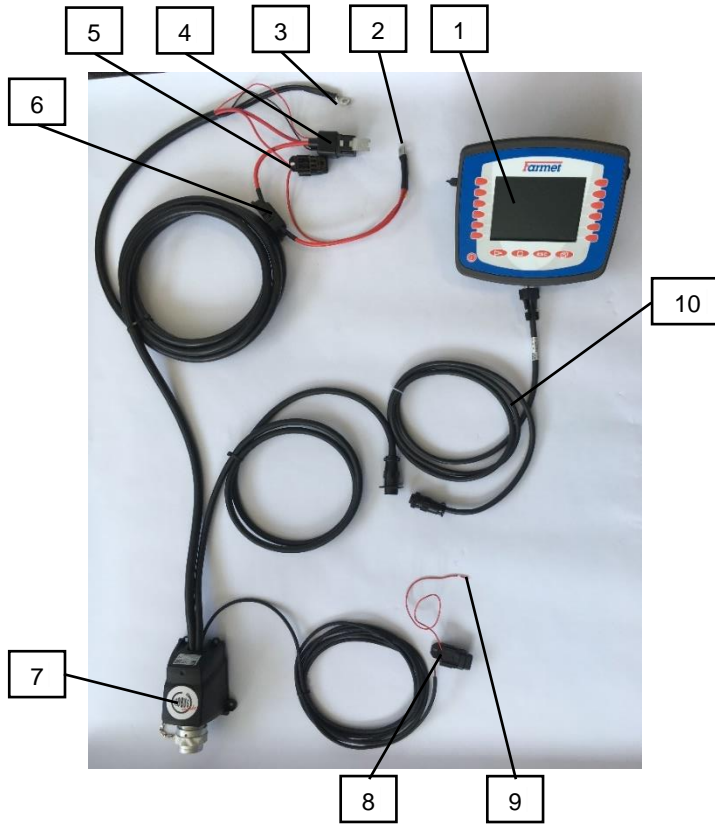

1	Terminal	6	Fuse 50 A
2	Positive battery pole „+“	7	ISO socket
3	Negative battery pole „-“	8	Fuse 1 A
4	Voltage relay	9	Ignition contact for relay switching
5	Fuse 15 A	10	Terminal connection cable



Due the disconnection of the unit from the battery, it is necessary to connect the ignition contact for closing the relay (9) to the ignition of the tractor, or to the switched 12 V (voltage 12 V switched by the key or switch).



10.4.2 Connecting the machine via the ISOBUS socket of the tractor + Müller terminal

- Connect the machine plug to the ISOBUS socket of the tractor.
- Use the reduction cable of the terminal and connect to the IN-CAB socket of the tractor and connect the terminal.
- For this use it is necessary to set the terminal as VT1, you can read this in the chapter **VT a TC settings** page - 23.

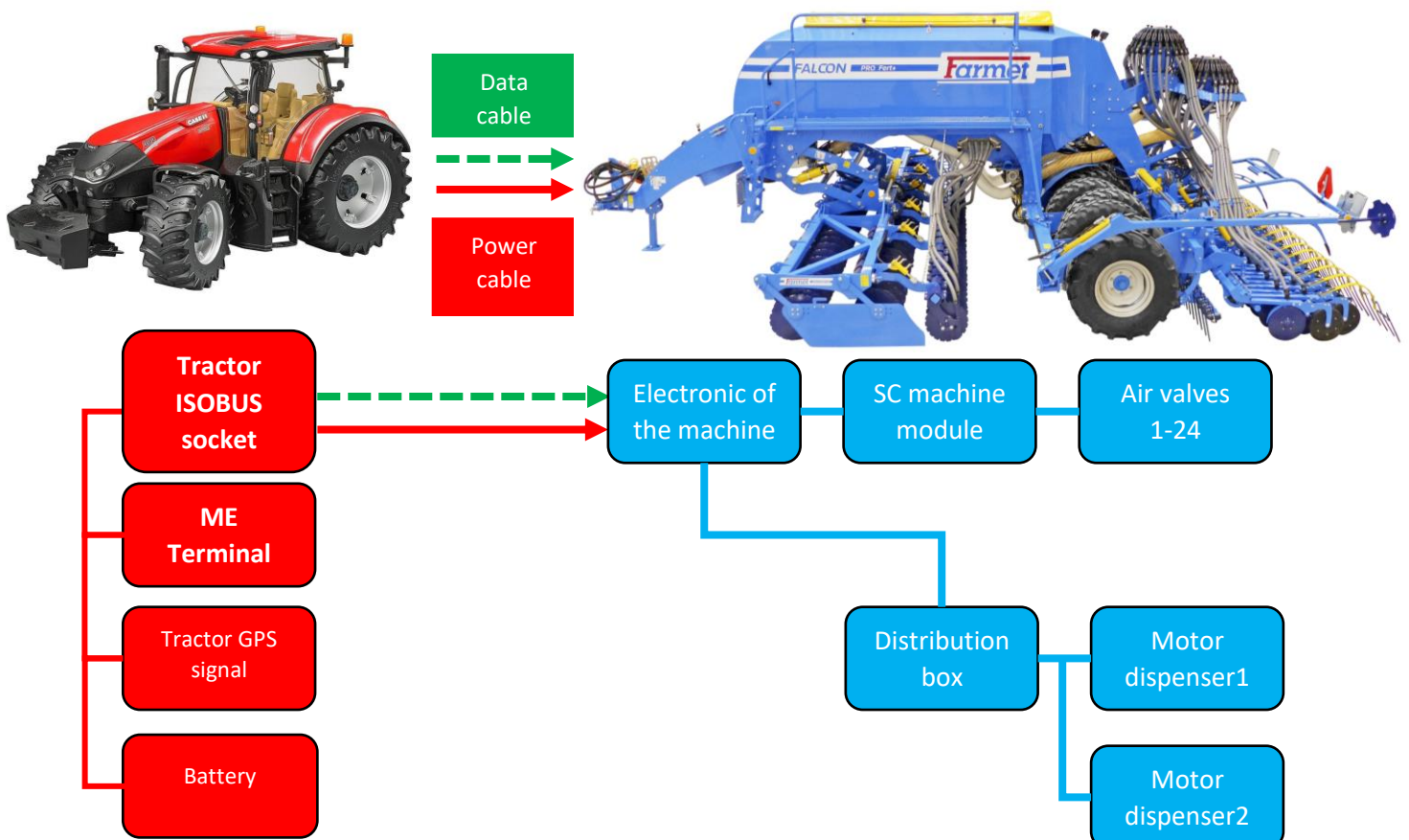

10.4.3 Connecting the machine via the tractor's ISOBUS socket + Tractor terminal

- Connect the machine plug to the tractor socket.
- ISOBUS VT must be switched on in the tractor settings.
- The machine application is loaded in the tractor ISOBUS application after 2-5 minutes (communication between the tractor and the machine must take place first).

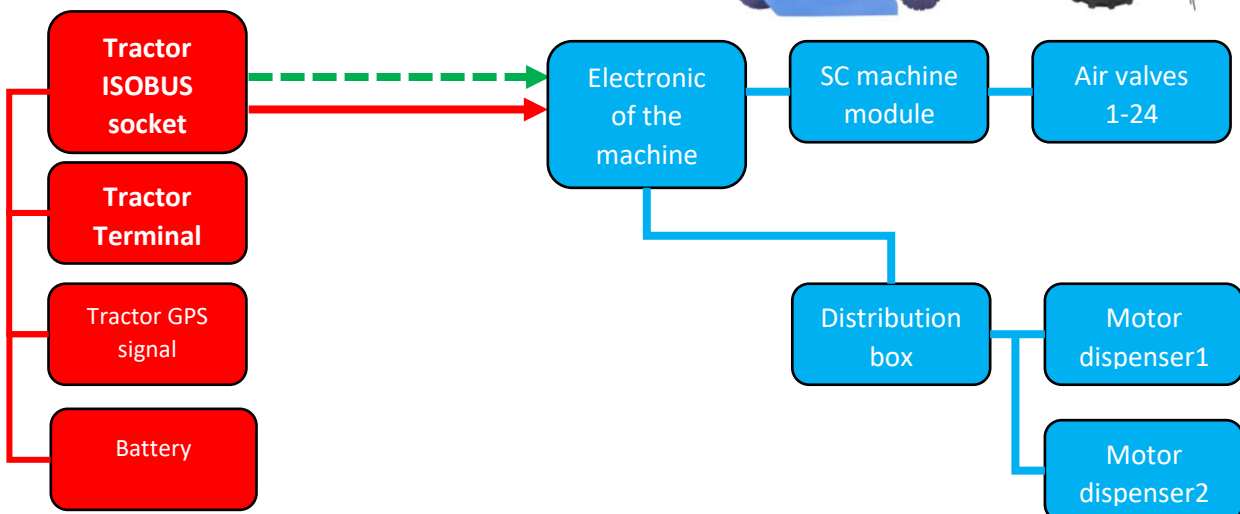
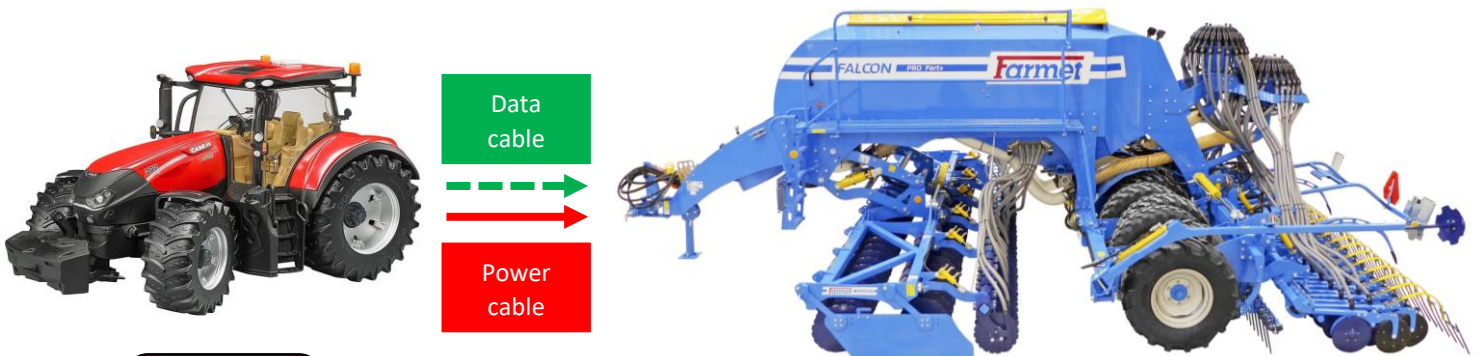

10.4.4 Selecting and setting up the virtual terminal (VT) and task manager (TC)

1.  Turn on the application

Touch



Basic



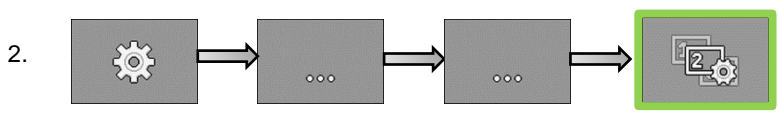

- Select which virtual terminal you want to use (VT), for example [Mueller](#) or [another terminal](#).
- For the basic terminal, it is necessary to select in the settings that it also work as a secondary terminal.

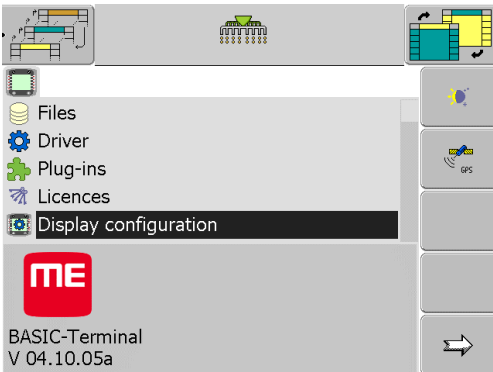

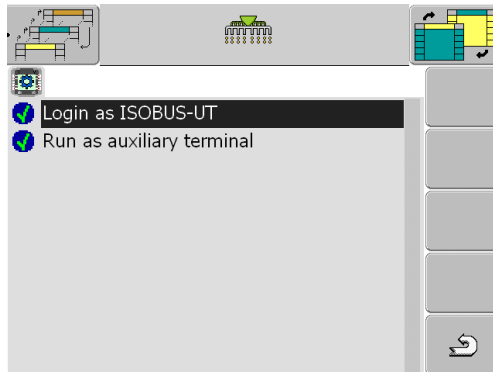

3. Select which task manager you want to use (TC), such as Mueller or other terminal.

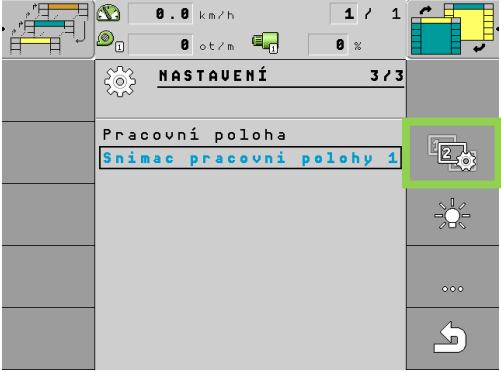

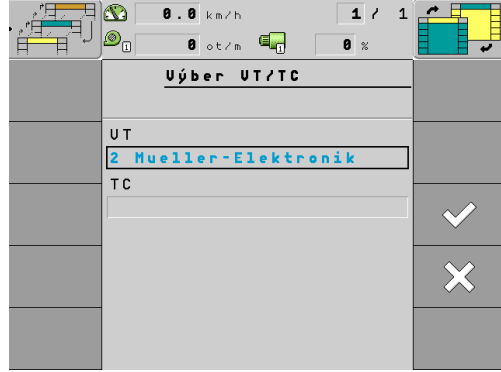

4.  -Confirm.

- Settings of virtual terminal and task manager is complete.

11 Machine fan



- The hydraulic drive of the fan is driven directly from the tractor switchboard.
- It is necessary that the fan drive is connected to the tractor's priority circuit to ensure that the fan speed does not drop in any sense.
- The fan speed is set directly in the tractor by regulating the oil flow of the circuit.



- Replacing of the quick coupling for the waste branch with less than ISO 20 is unacceptable.

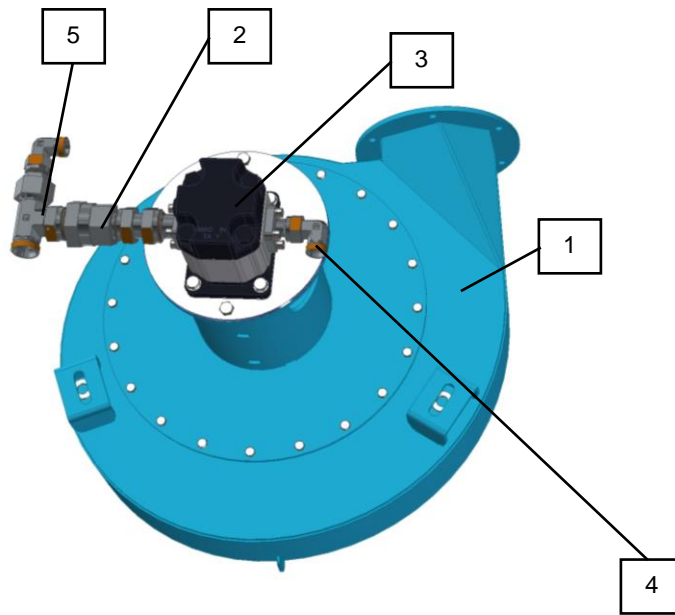

*See page 3 for your machine configuration.

1	Small fan V1	4	Pressure hose ISO 12.5 (P)
2	Reverse throttle valve	5	Return waste branch ISO 20 (T)
3	Hydraulic engine		

Hydraulic fan motor	Hydraulic engine capacity per revolution		8 cm ³ /rev.
	Small fan	Maximum speed	5500 (rev. /min.)
		Minimum speed	1000 (rev. /min.)
Pressure branch (P)	Minimum pressure in the pressure hose		130 (bar)
	Maximum pressure flow in the pressure hose		50 (l/min.)
Return waste branch (T)	Maximum pressure in the return waste branch		5 (bar)



In case, if free waste is not fitted to the tank as standard on the tractor, contact the tractor manufacturer (dealer), who will provide you with information on the options for the free waste terminal.

- Hydraulic connection of the fan drive

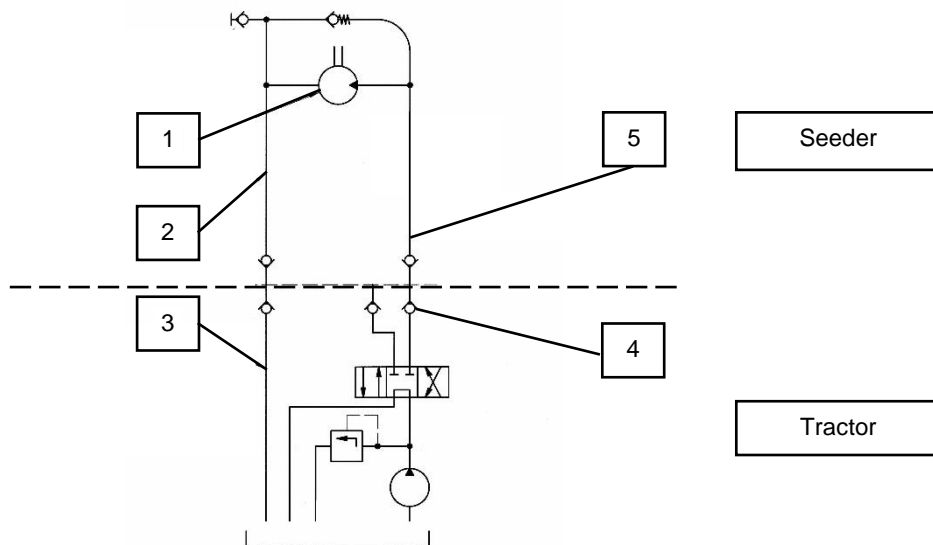

1	Fan hydraulic motor	4	Quick coupler of tractor switchboard
2	Waste branch ISO 20 (T)	5	Pressure hose ISO 12,5 (P)
3	Free waste in the tractor tank		



Farmet a.s. is not liable for damage to the hydraulic drive or tractor caused by incorrect connection of the hydraulic drive.

11.1 Fan with separate drive on PTO

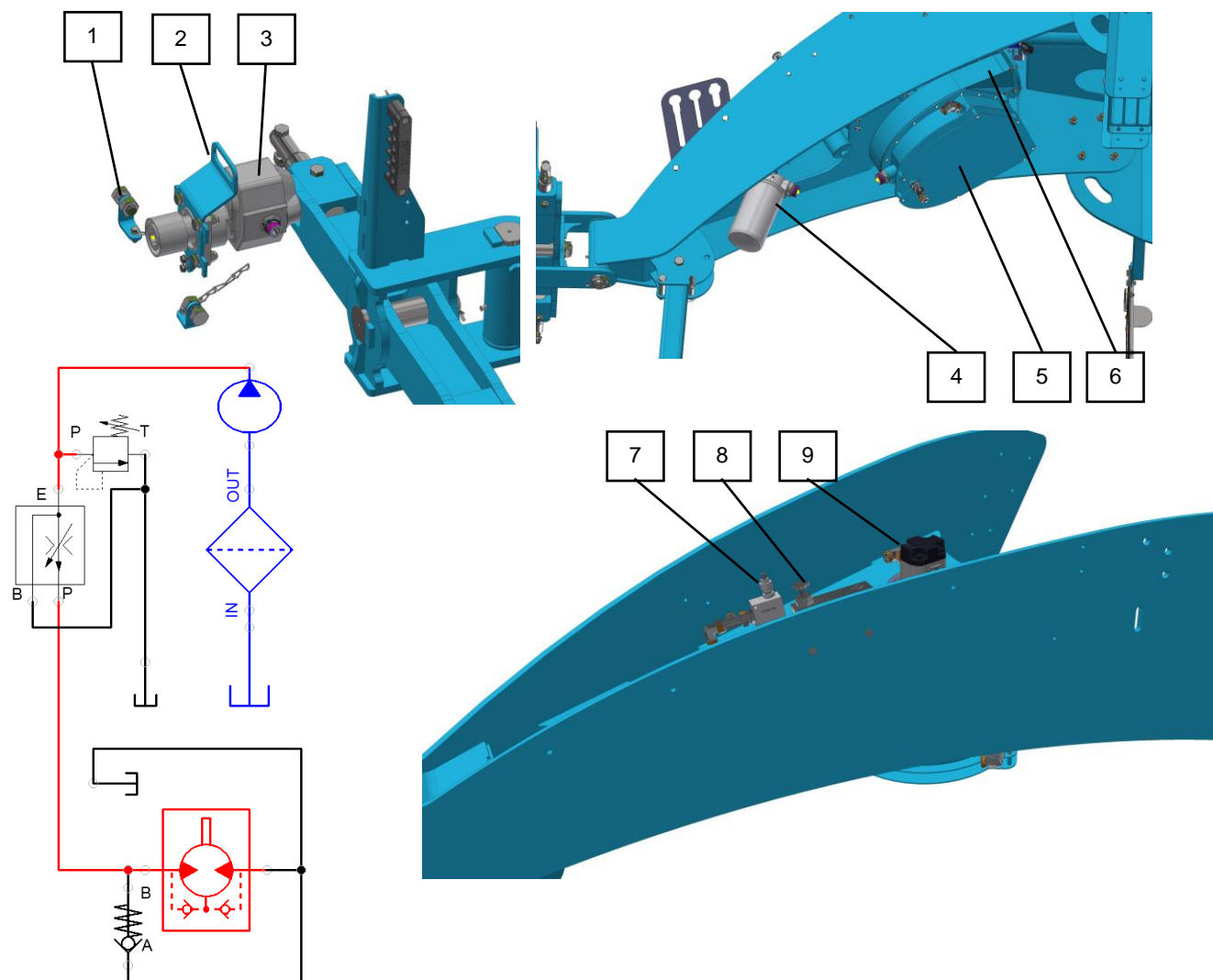

1	Generator locking screw	6	Ventilator
2	Handling handle	7	Safety valve
3	Hydraulic generator	8	Fan speed reducing valve
4	Low pressure oil filter	9	Hydraulic fan motor
5	Oil tank		



- Securing the hydraulic generator against rotation with chains.
- Always use the fan on the PTO with a setting of 540 rpm. / min.

Methods to set the fan speed:

1. Connect the hydraulic generator (3) to the tractor PTO.
2. Set the working speed on the tractor (540 rev. /min.).
3. Use the reducing valve (8) to set the required fan speed.
4. Check the speed on the machine monitor.

11.2 Fan speed setting according to seed

*See [page 3](#) for your machine configuration.

Falcon Compact 3 Falcon Compact 4	V1	
	Crop	Speed of fan
	Grain	4000–5500
	Legumes	4000–5500
	Pea	5000–5700
	Rape	2500–2700
	Clover	3000–3500
	Grass	3000–3500

12 Seed switching sensors

- Sowing switching is switched off and off by two sensors.
- The system is designed so that sowing is switched at the beginning of the countersinking. Before the seed passes through the entire pneumatic distribution system, the machine is recessed and it is minimized the sowing start delay at the start of the journey.
- On the contrary, sowing is switched off at the very beginning of excavation.

12.1 Sowing switching

- Switching is secured by an antenna sensor. The antenna sensor is set to close right at the beginning of the countersinking.
- If the sensor is in a horizontal position (as in the picture), it means that the machine is in the working position.
- The moment at which the sowing is switched on depends on the position of the sensor set between the seed frame and the main machine frame.

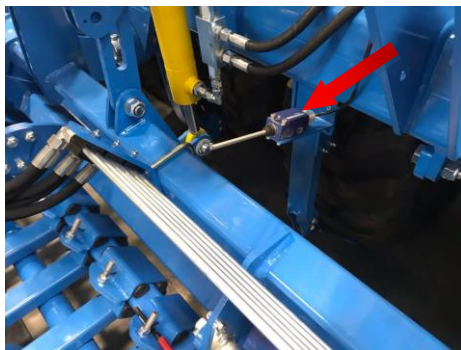

- If the seed section frame is in the upper position, the sensor must be in the closed position.

12.2 Sowing off

- The sowing is switched off by a pressure sensor, which is located on the hydraulic circuit for raising the seed section.
 - The sensitivity of this sensor is set to a pressure of 100 Bar.
 - When excavating the machine, oil pressure is supplied to the hydraulic distributor, when the set value is reached, the switch is closed and the motors of the seed and fertilizer metering units are deactivated.
- !
- For this reason, move the hydraulic control lever to the float position after deepening the machine into the working position.
 - The sensitivity of the pressure and antenna sensor is set by the manufacturer as standard. Settings may only be changed by a specialist.

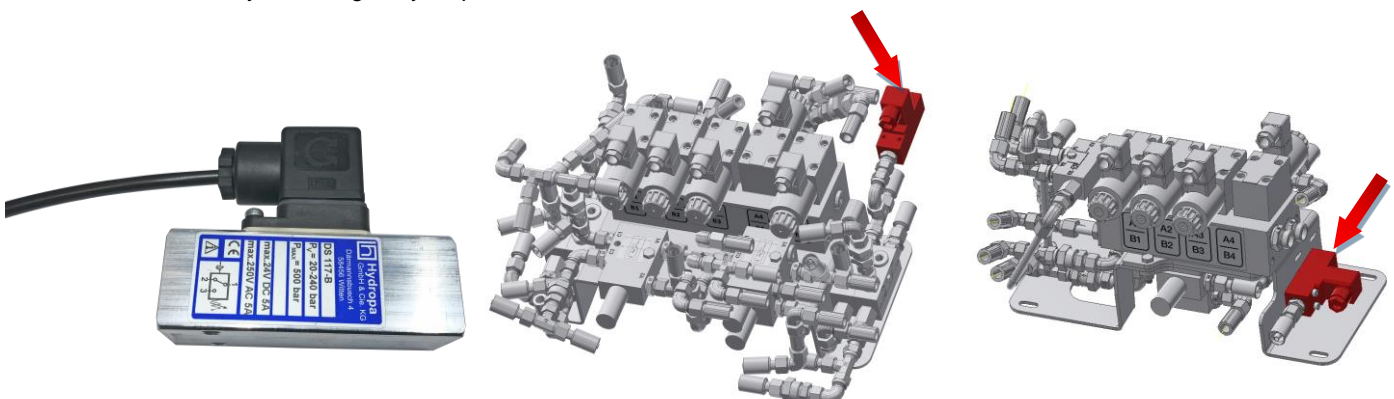

13 Electronic machine control Müller Electronic

- The electronic system controls all functions that are connected to the blue hydraulic circuit.

13.1 Work screen

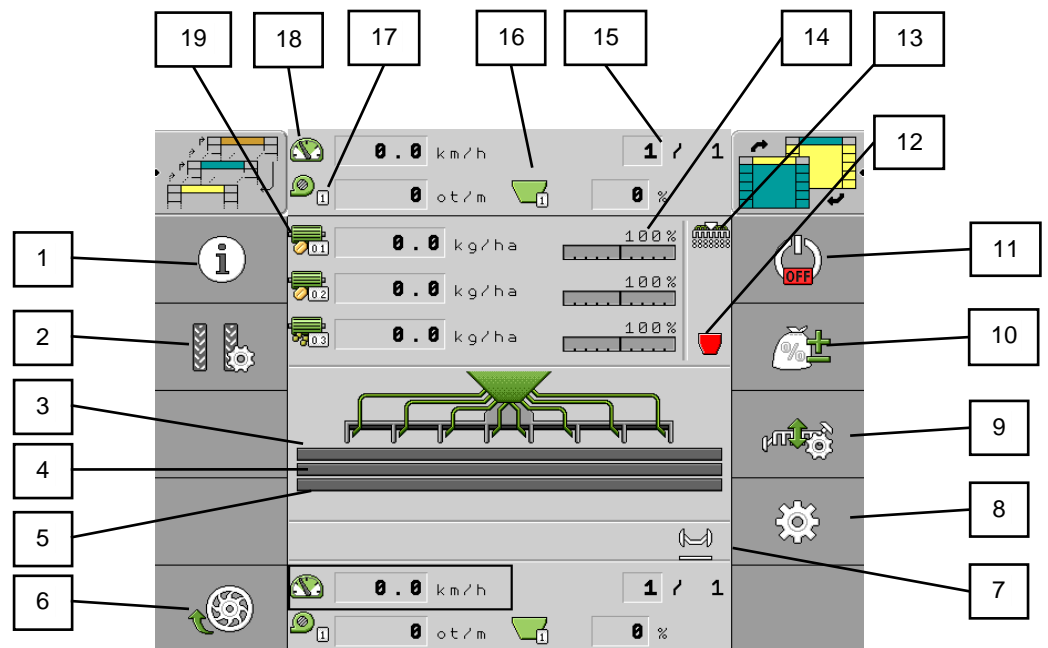

1	Job information	11	Turn off the work application
2	Tramline settings	12	Empty tray indication
3	Motor 1 (dispenser)	13	Sensor information field (machine in working position)
4	Motor 2 (dispenser)	14	Adjusted target dose field in %
5	Motor 3 (dispenser)	15	Trip counting for tramlines
6	Site sowing function	16	Current state of the hopper 1/2/3 (can be changed)
7	Fields of active functions (markers, obstacle, swamp)	17	Speed of fan
8	Settings	18	Travel speed of the machine
9	Control of hydraulic functions of the machine	19	Dispenser dose information 1/2/3
10	Sowing rate correction		

	Beacon is activated.		Both markers activated manually.
	Hopper lights are activated.		Manually activated left marker.
	Working light is activated.		Manually activated right marker.
	Function swamp is activated.		Markers are deactivated.
	The dispensers are filled with seed.		Automatic markers (first left)
	ISOBUS-TC is activated.		Automatic markers (first right).
	Section-Control is activated, including GPS		Obstacle function.
	Hopper is empty.		Working speed of the machine.
	Machine is in working position.		A tramline is being created.
	An earlier engine stop is activated.		Calculated system pressure.



*All icons on the terminal side are function keys (two-column image).

13.2 Information

1. On the work screen.



Function icon	Meaning
	Resetting the daily counter.
	Counter summary information.
	Task list (TASK).
	Total stack counter.

- **Area** – The area on which the machine was in the working position.
- **Quantity** – Applied amount.
- **Area performance** – Applied area per hour.

2. - Counter summary information.

- **Operating hours** – Period time for which the computer is turned on.
- **Total hours** – Period time, which the machine was working for.
- **Total distance** – Worked distance.
- **Total area** – Worked area.
- **Area performance** – Applied area per hour.

13.3 Creating a task with a computer

- This function allows you to create an order, for an overview of information about the work performed.

1. On the working screen.

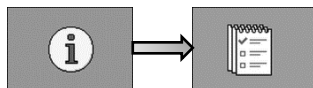

- **Order** – Select an existing one or create a new task.
- **Rename** – Here you can name the order.
- **Product** – Here we assign the product (**MOTOR** / **SEED** / **FERT**).

2. After the end of contract.

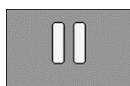

3. It is possible to reset the counter.



13.4 Remaining calculated amount in the hopper

- On the screen Results / The hopper will see counters that show the amount remaining in the hopper and how much work can still be done with the remaining contents of the hopper.

1. On the working screen .

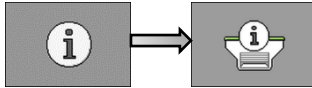

- **Leftover amount** – Remaining sum in the hopper.
- **Leftover area** – Area where you can still work with the remaining sum in the hopper.
- **Leftover track** – The distance that can still be traveled with the remaining sum in the hopper.

2.  Use to return to the work screen.

13.5 GPS settings for machines when unfolding in the hall

For service purposes of the machine in the hall, it is necessary to set the simulated speed to 0 km/h when unfolding the machine in the hall.

- 1 Turn off the application

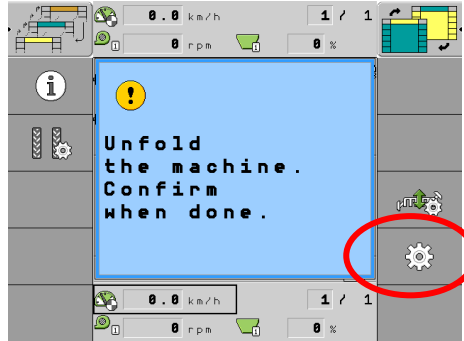
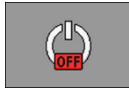

- 2

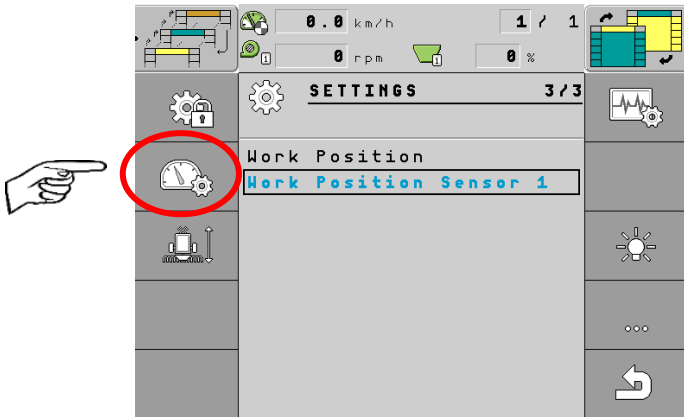
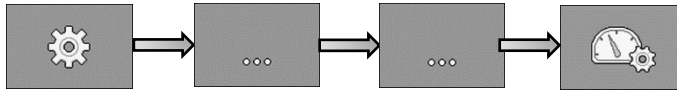

- 3.

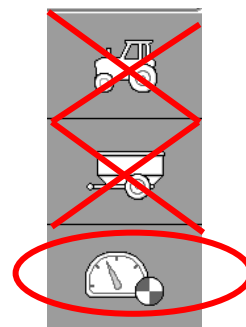
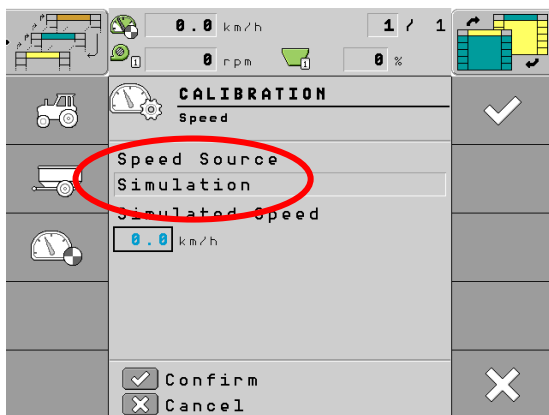

Set the speed source to 0 km/h!

13.6 Control and settings of the markers

- The markers are adjustable only to the center of the tractor, they copy the terrain, each track marker can be controlled separately and they are hydraulically tiltable.
- The distance of engagement of the marker disc is always measured from the center of the seed coulters. The markers must be set to the correct length in the field.



The markers are only activated when the machine is in the working position.

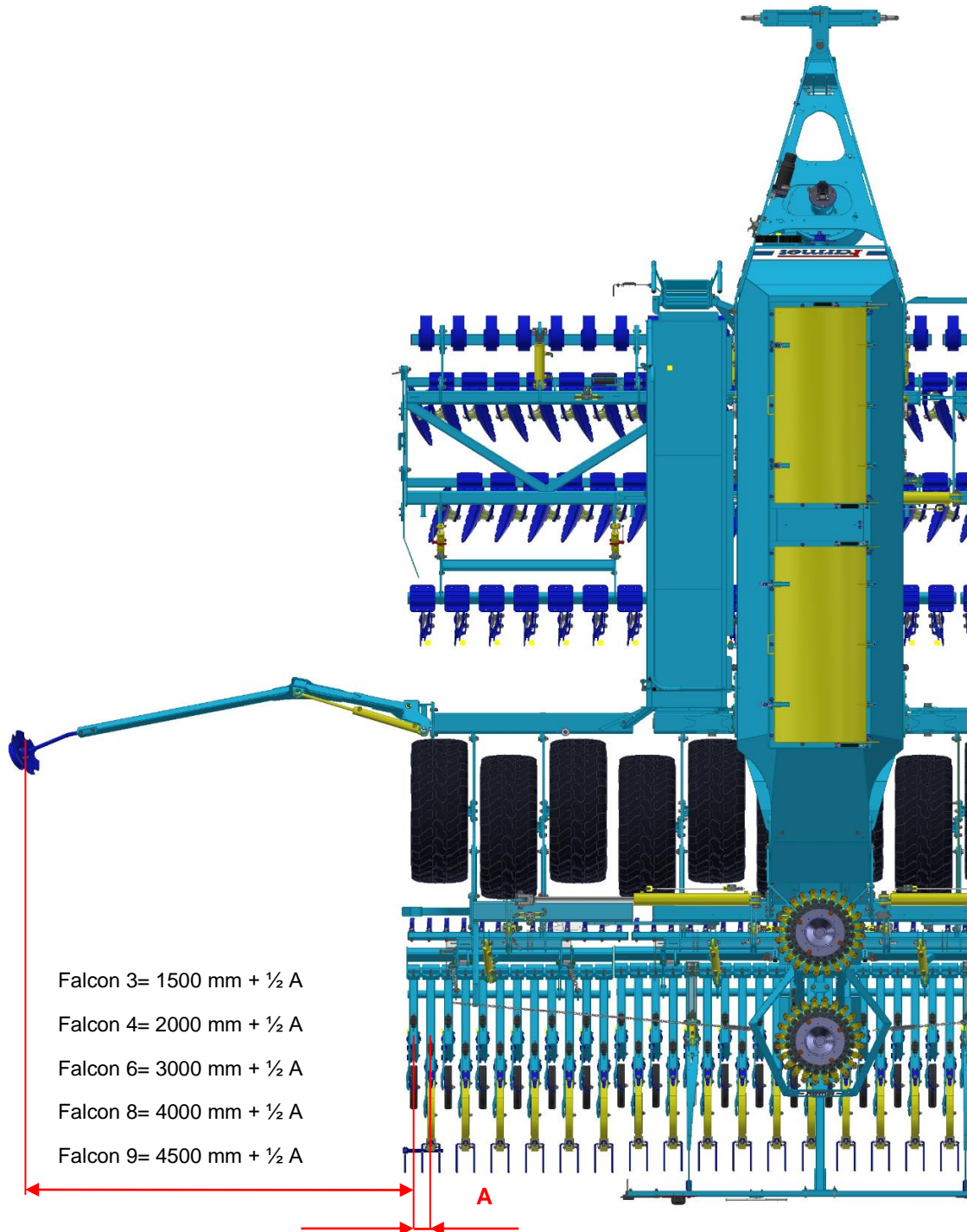

13.6.1 Settings of aggressivity of the markers

- Adjust the aggressivity of the markers depending on the soil conditions.
1. Loosen the hexagonal screws (1).

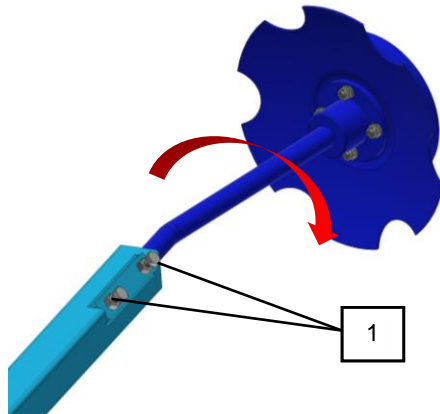



1	Hexagonal safety screws
---	-------------------------



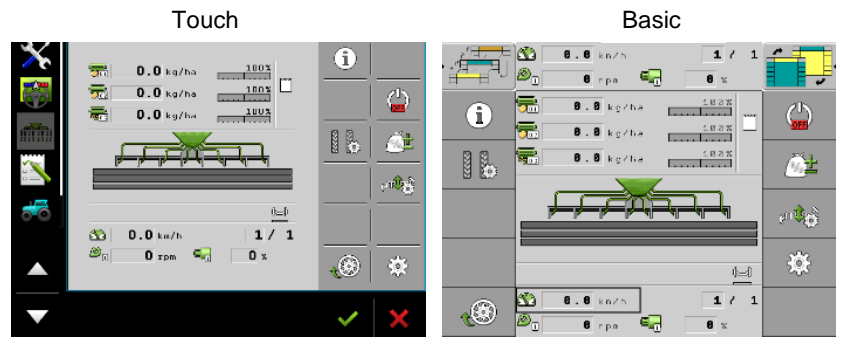

2. Adjust the marker and retighten the hexagonal screws.
3. Check the quality of the work of the markers and adjust the marker settings if necessary.

13.6.2 The markers control

1.  Turn on the application

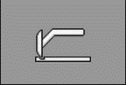
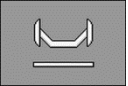

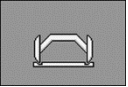
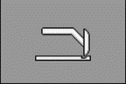
2.  - Hydraulic control.
3.  - The markers control.

Function icon	Meaning
	Control of the left marker only.
	Deactivate marker control.
	Obstacle function- the hydraulics only control the marker without the rear sowing section.
	Control of both markers at the same time.
	Control of the right marker only.
	Automatic change of the marker when the seeding section is raised.
	Manual marker change in automatic mode.







4. After selecting the function, apply pressure to  .



The markers are controlled by a blue hydraulic circuit at the same time as the sowing section.







13.6.3 Obstacle function

- If the obstacle function is activated, the hydraulic circuit only controls the markers and the sowing section is still in the working position.

1.  - Hydraulic control.
2.  - The markers control.
3.  - The obstacle activation.
4. The activated obstacle function is displayed on the work screen  .
5. Apply pressure to. 
6. Detour the obstacle and then apply pressure. 
7.  - Deactivation of an obstacle.

13.6.4 Swamp function

- The swamp function is used to raise the sowing section, without cancelling the sowing.

1. The machine must be in working position  .
2.  - Hydraulic control.
3.  - Activate function swamp.
4. The activated swamp function is displayed on the work screen. 
5. Apply pressure to,  sowing section is lifting but the machine is still working.
6. Apply pressure to,  sowing section is deepens.
7.  - Deactivation of the swamp function.

13.7 Enter the hopper fill

- The system allows the calculation of the tank status in real time, based on a calibration test. This function is not necessary for the correct operation of the machine.

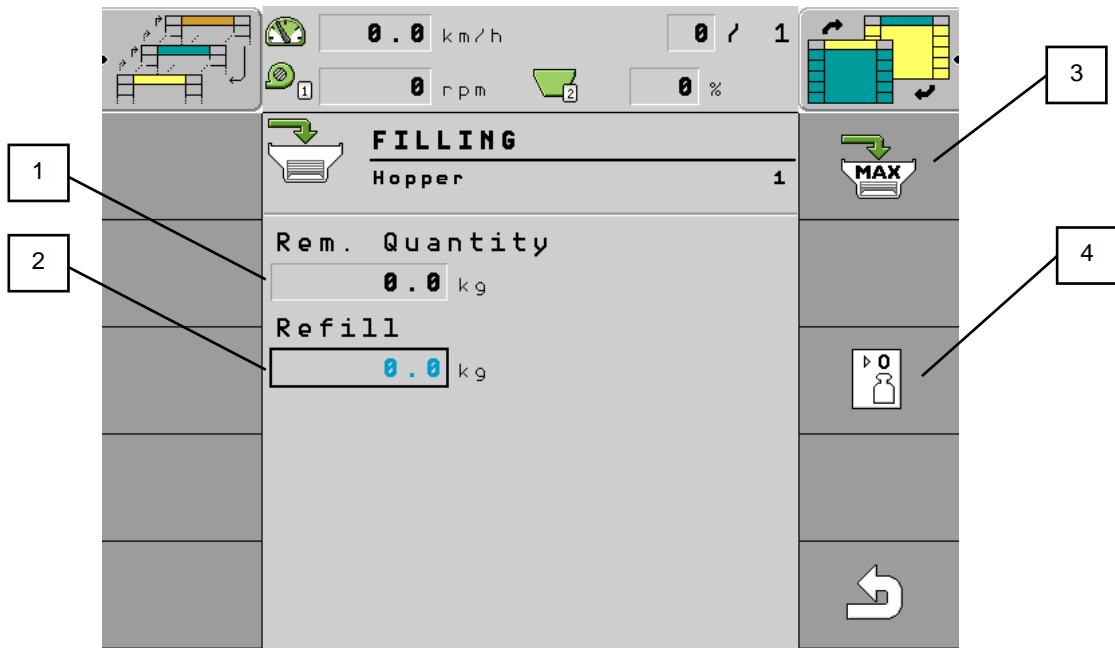
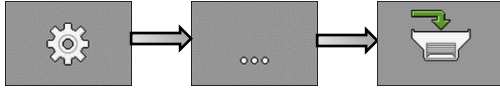

1	Current residual amount in the hopper	3	Maximum filling of the tank
2	Write the quantity poured into the hopper here	4	Resetting the state in the hopper

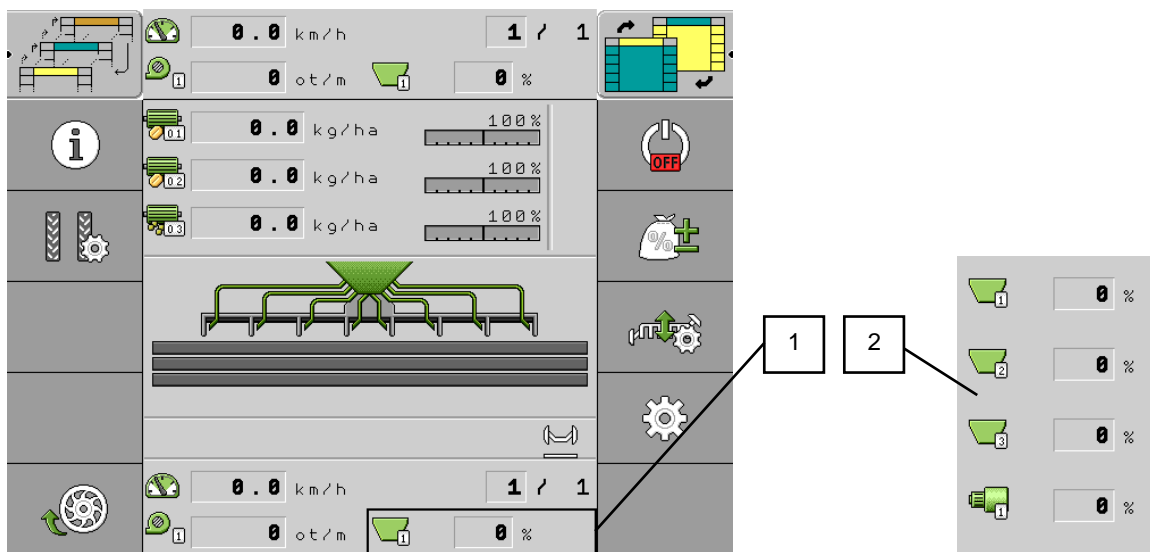

1	Hopper 1 status indicator in % based on sowing test	2	Open menu of real-time values (choose which ones I currently want to display)
---	---	---	---

13.8 User product database

-  Shutting down the application

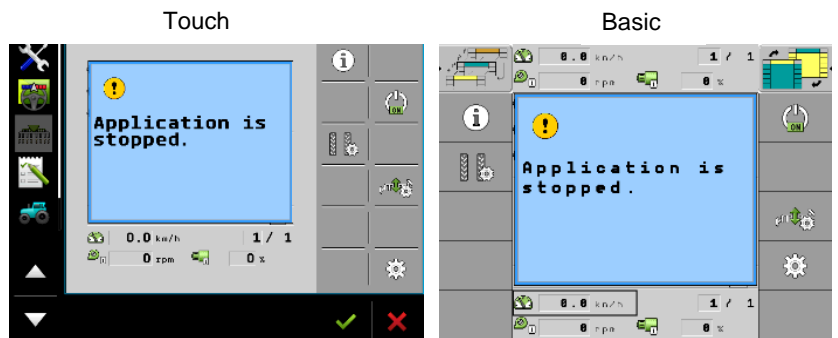

-

Product

- Here I choose which motor I want to modify (motor **1,2,3**, or **Seed / Fertilizer**) according to the machine configuration.

Rename

- Here you can rename the product.

Type of product

- For the engine, select the product type seed / solid fertilizer / liquid fertilizer / undefined.

Note

- Here you can enter any note, for example MARGED.

Adapt

- Here it is possible to set a percentage value by which the required dose value can be changed manually during work.

Example: 1x press by 10 %, 2x press by 20 %

Gear ratio

- If there is a gear behind the outlet shaft motor, it must be entered here. The motor shaft speed is entered first and then the metering unit speed.

Example: 2 rev. motor / 1 rev. dispenser

Level alarm

Low / Empty – Only if two sensors are used one above the other for one dispenser.

Empty – In case of using one sensor for the dispenser.

Deactivate – To deactivate the dispenser sensor.

Deviation tolerance

- For each motor, enter the deviation from the required dose above which an alarm should be triggered.
- For a precision seed machine the deviation tolerance applies to each row.
- The left value applies to the upward deviation and the right value to the downward deviation.



13.9 Assignment of the motor to the given hopper

-  Shutting down the application.

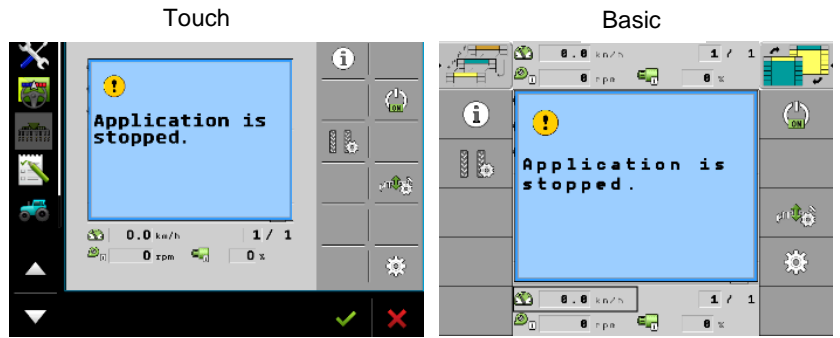

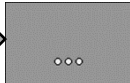
-  → 



1	Settings of hopper 1 / motor 1	2	Assigned product from the product database
---	--------------------------------	---	--

13.10 Activation / Deactivation dispenser

- This function is used to deactivate the metering motor, which we do not want too use during work (sowing with one metering unit, deactivation of fertilization).

1.  – Settings.

2. Select the **product** (dispenser) that you want to deactivate by pressing on its name (**MOTOR 1**). 

3.  - Deactivation / Activation

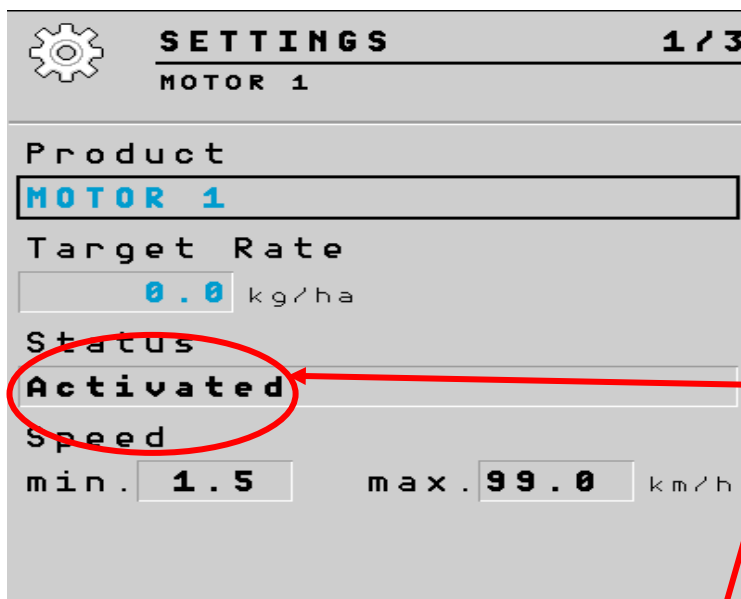

4. This shows the deactivated dispenser on the desktop.



- After switching the terminal off and on again, the dispenser is always reset (activated).

13.11 Seed flow sensing Dickey-John-deactivation

1.  Shutting down the application

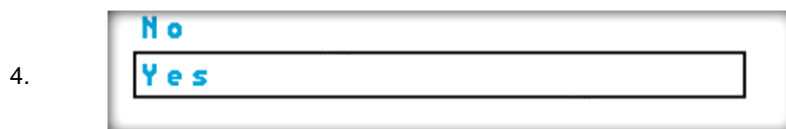
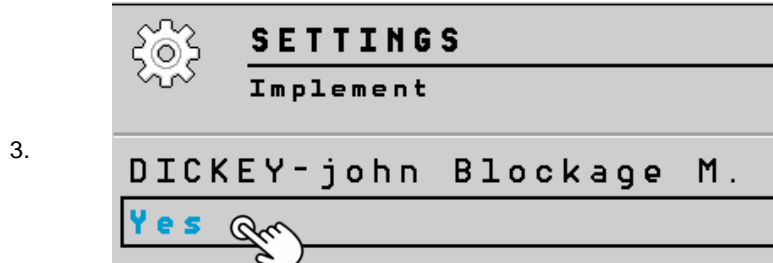
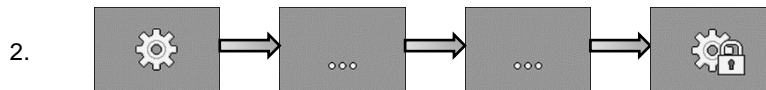
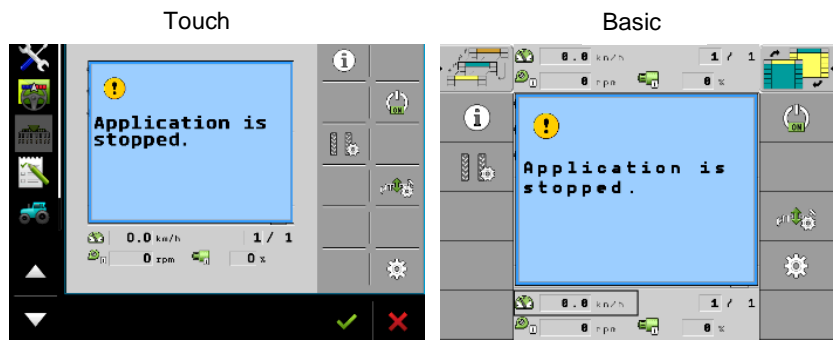

5. Seed flow sensing deactivated.
6. To reactivate the sensors, select YES.

14 Rail lines

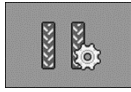

- Rail lines settings.

Functional icon	Meaning
	<p>Adds driving</p> <p>E.g. to set the number of rides correctly after returning to the field. This function is only available when the machine is stopped and not in the working position.</p>
	<p>Subtract the ride.</p> <p>E.g. To set the number of rides correctly after returning to the field. This function is only available when the machine is stopped and not in the working position.</p>
	<p>Deactivation the automatic addition of trips.</p> <p> If the tramline counting is stopped, the machine will do the tramline continuously.</p>
	<p>Opens the screen for setting the tramline rhythm.</p>

14.1 Rail lines set on and off

RhNo.	Program number.
Length	The period when the cycles start to repeat.
Left, Right	Specifies the travel in which the tramline on the left or right side of the machine is activated.
Individual settings	Here we can choose our own settings.

14.2 Steps for setting the tramline rhythm correctly

Necessary information for calculating the rhythm of tramlines.

1. Seeder grip
2. Sprayer grip

We will perform calculation.

$$\text{Result of the calculation} = \frac{\text{Sprayer grip}}{\text{Seeder grip}}$$

Possibilities of creating tramlines

1. Even results – Even tramline rhythms (15.2.1)
2. Odd result – Odd tramline rhythms (15.2.2)
3. Decimal results – Special tramline rhythms (15.2.3)

Types of valves placement on the machine

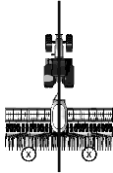
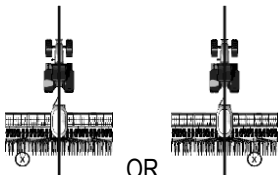
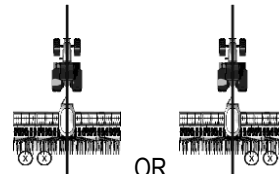
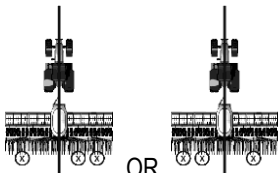
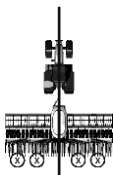
	<ul style="list-style-type: none"> - TYPE A - One valve on each side of the machine.
 <p style="text-align: center;">OR</p>	<ul style="list-style-type: none"> - TYPE B - One valve on one side of the machine.
 <p style="text-align: center;">OR</p>	<ul style="list-style-type: none"> - TYPE C - Two valves on one side of the machine.
 <p style="text-align: center;">OR</p>	<ul style="list-style-type: none"> - TYPE D - One valve on one side of the machine and two valves on the other side of the machine.
	<ul style="list-style-type: none"> - TYPE E - Two valves on each side of the machine and each side of the machine create a complete rail line for the entire sprayer (2 tracks).

14.2.1 Even tramline rhythms

- It is possible to create an even tramline during one or two runs.
- 1. During one run, tramlines are created on both sides of the machine.
- 2. During two runs, tramlines are created, the valve is located only on one side of the machine.
- 3. During one run, tramlines are created, both valves are on one side of the machine.

Example: Creating a tramline on both sides of the machine at the same time.

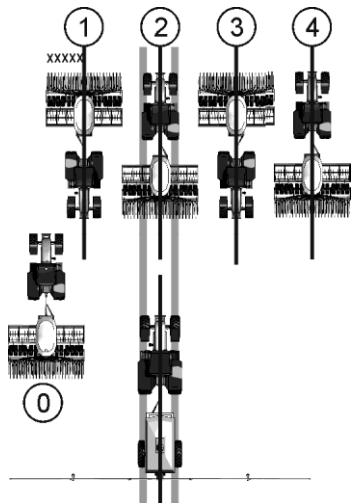





- The example shows a 4s rhythm
- Rail lines are created in two runs (sprayer 12 m, seeder 3 m)
- Run 0 must be done separately.
- For run 0 trip counting must be deactivated.



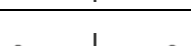
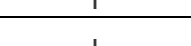

Creating a tramline in one run TYPE A

Possible valve positions	Result of the calculation	RhNo.	The resulting rhythm	Left valves		Right valves	
	2	2s	2		1		1
	4	4s	4		2		2
	6	6s	6		3		3
	8	8s	8		4		4
	10	10s	10		5		5
	12	12s	12		6		6
	14	999	14		7		7

Start sowing from the left side of the TYPE B field

Possible valve positions	Result of the calculation	RhNo.	The resulting rhythm	Left valves		Right valves	
	2	2L	2			2	1
	4	4L	4	3	2		
	6	6L	6			4	3
	8	8L	8	5	4		
	10	10L	10			6	5
	12	12L	12	7	6		
	14	14L	14			8	7

Start sowing from the right side of the TYPE B field

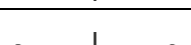
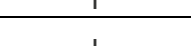
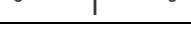
Possible valve positions	Result of the calculation	RhNo.	The resulting rhythm	Left valves		Right valves	
	2	2P	2	2	1		
	4	4P	4			3	2
	6	6P	6	4	3		
	8	8P	8			5	4
	10	10P	10	6	5		
	12	12P	12			7	6
	14	14P	14	8	7		

Example: Creating a tramline on one side of the machine on which are both valves.

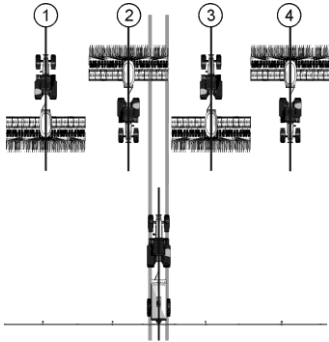

- The example shows an individual rhythm.
- Rail lines are created in two runs (sprayer 24 m, seeder 6m)

Start of sowing from the left side of the field, individual rhythm TYPE C/E

Possible valve positions	Result of the calculation	RhNo.	The resulting rhythm	Left valves		Right valves	
	2	999	2				1
	4	999	4		2		
	6	999	6				3

Start of sowing from the right side of the field, individual rhythm TYPE C/E

Possible valve positions	Result of the calculation	RhNo.	The resulting rhythm	Left valves		Right valves	
	2	999	2		1		
	4	999	4				2
	6	999	6		3		

14.2.2 Odd rhythms of tramlines

- Odd tramline rhythms are always created in one run. Odd tramline can only be created if the valves are on both sides of the machine.

Example: Creating a tramline one in one run.

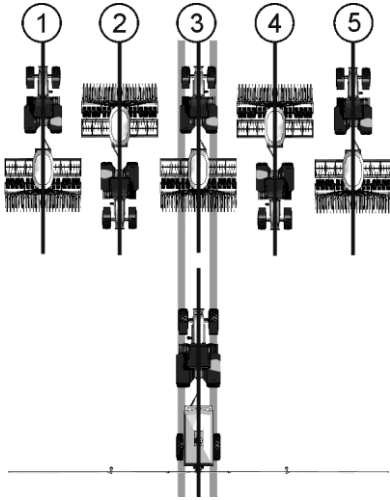

- The example shows rhythm number 5.
- The tramlines are created in the third run (sprayer 15m, seeder 3m)

Creating a tramline in one run TYPE A

Possible valve positions	Result of the calculation	RhNo.	The resulting rhythm	Left valves		Right valves	
	3	3	3		2		2
	5	5	5		3		3
	7	7	7		4		4
	9	9	9		5		5
	11	11	11		6		6

14.2.3 Special tramline rhythms

- Special rhythms are always created during four runs, they can only be created if the tramline valves are arranged on both sides of the machine.
- One tramline valve is on one side and two valves are on the other side of the machine.

Example: Creating a tramline with a special rhythm.

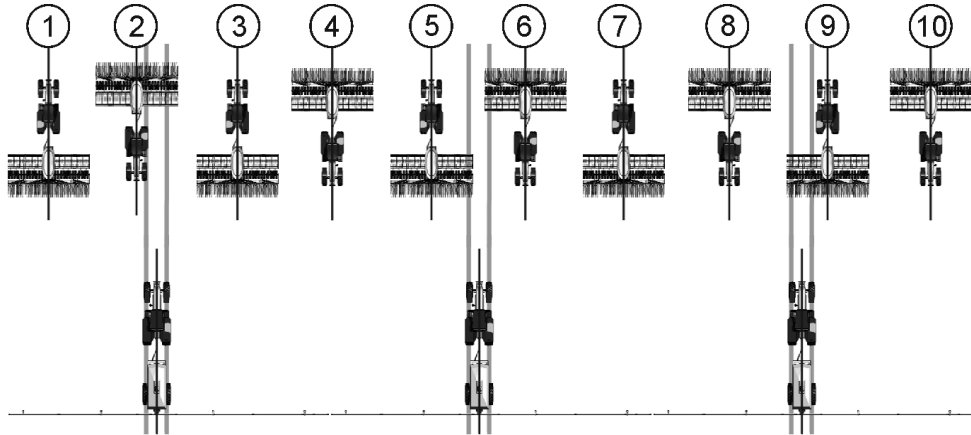

- The example shows rhythm number 20.
- Rail lines are created during runs 2,5,6 and 9 (sprayer 20 m, seeder 6 m)

Start of sowing from the left side of the TYPE C/D/E field

Possible valve positions	Result of the calculation	RhNo.	The resulting rhythm	Left valve				Right valve					
				3	2	1	4	4	3	6	1		
	1.33	999	4										
	1.5	22	6										
	2.5	16	10										
	2.67	62L	8										
	3.33	20	10										

Possible valve positions	Result of the calculation	RhNo.	The resulting rhythm	Left valve		Right valve	
	3.5	28	14	13	2	9	6
	4.5	18	18	16	3	12	7
	4.67	63L	14	3	12	7	8
	5.33	24	16	9	8	14	3
	5.5	65L	22	14	9	3	20
	6.67	64L	20	10	11	4	17
	7.5	30	30	27	4	19	12
	9.33	999	28	14	15	5	24

Start of sowing from the right side of the field TYPE C/D/E

Possible valve positions	Result of the calculation	RhNo.	The resulting rhythm	Left valves		Right valves	
	1.33	999	4	1	4	3	2
	1.5	23	6	6	1	4	3
	2.5	15	10	9	2	7	4

Possible valve positions	Result of the calculation	RhNo.	The resulting rhythm	Left valves		Right valves	
	2.67	62R	8	7	2	5	4
	3.33	21	10	6	5	9	2
	3.5	29	14	9	6	13	2
	4.5	19	18	12	7	16	3
	4.67	63R	14	7	8	3	12
	5.33	25	16	14	3	9	8
	5.5	65R	22	3	20	14	9
	6.67	64R	20	4	17	10	11
	7.5	31	30	19	12	27	4
	9.33	999	28	5	24	14	15

14.3 The most frequently used tramline settings

The specific tramline setting is done in the tramline setting screen itself. For a better orientation and understanding of the setting of the tramlines, we present graphic and tabular processing here. The system for determining the rhythm of the tramlines follows from the graphic representation and the table.

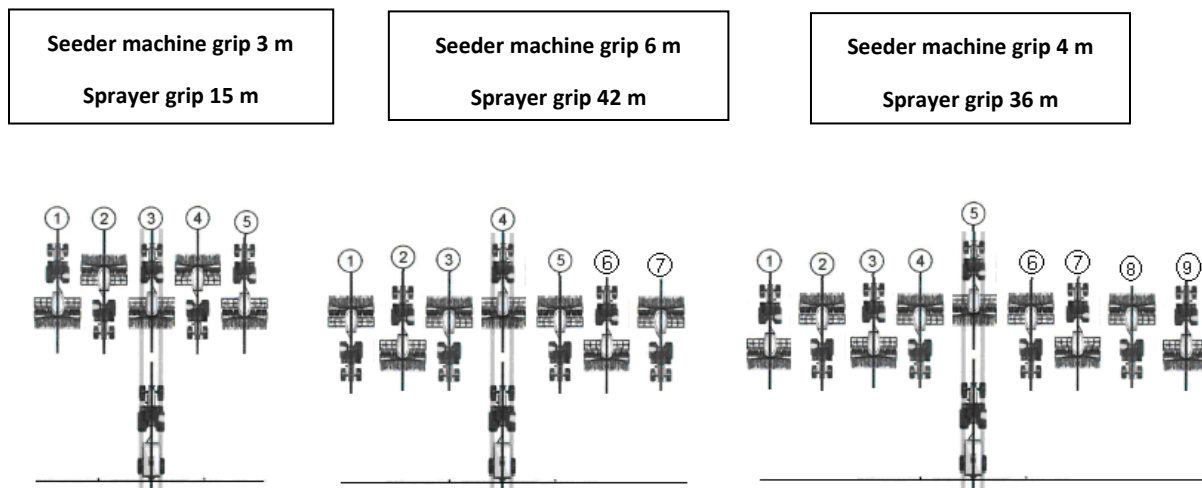

Grip of the machine (m)	Grip of the sprayer (m)	Program (Number of line)	Number of rides per machine width (length)	Left	Right
3	15	5	5	3	3
3	21	7	7	4	4
3	27	9	9	5	5
4	20	5	5	3	3
4	28	7	7	4	4
4	36	9	9	5	5
6	18	3	3	2	2
6	30	5	5	3	3
6	42	7	7	4	4
8	24	3	3	2	2
8	40	5	5	3	3

14.4 Rail line valves



- The tramline valves are closed with compressed air. It is necessary to have a red air hose connected to the compressed air connection from the tractor.
- For valves, it is important that no pressure escapes anywhere in the entire system.
- The pressure reducing valve must be set to 0,2 MPA.
- Check the valve drip tray.
- When the valve is running, the red signal light on the switchboard must always be on.

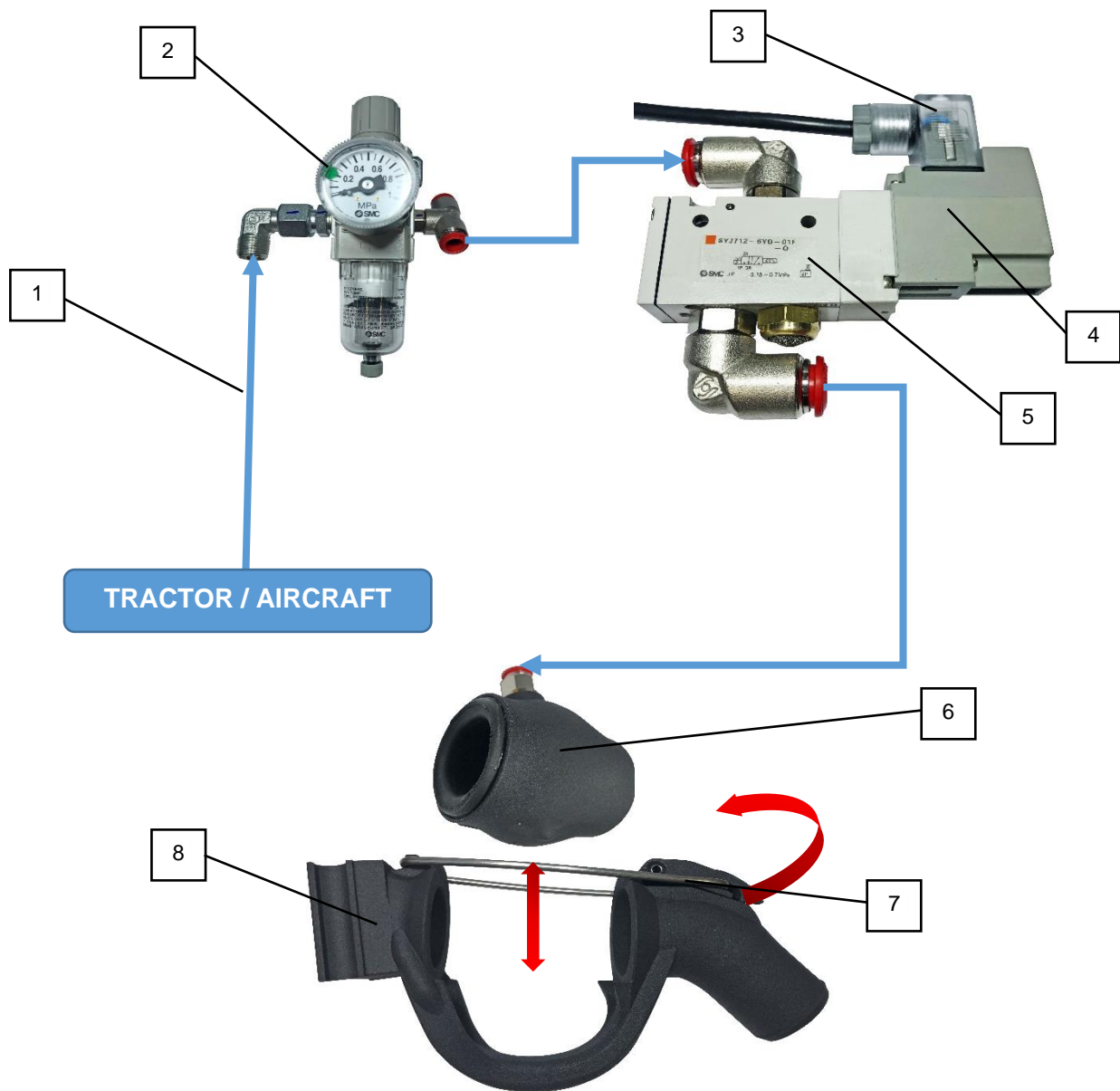

1	Compressed air supply from the tractor	5	Air distributor
2	Air pressure reducing valve	6	Air valve
3	Connector with red signal light	7	Secure locking lever valve
4	Switchboard solenoid	8	Body of air valve

14.5 Air pressure reducing valve of the tramlines

- The air pressure reducing valve is located on the seed drill head holder.
1. Slide out (upwards) the valve adjustment segment.
 2. Tighten to add pressure.
 3. Release to reduce pressure.
 4. After setting the required pressure of **0,2 MPA**, slide in the adjusting segment (downwards).

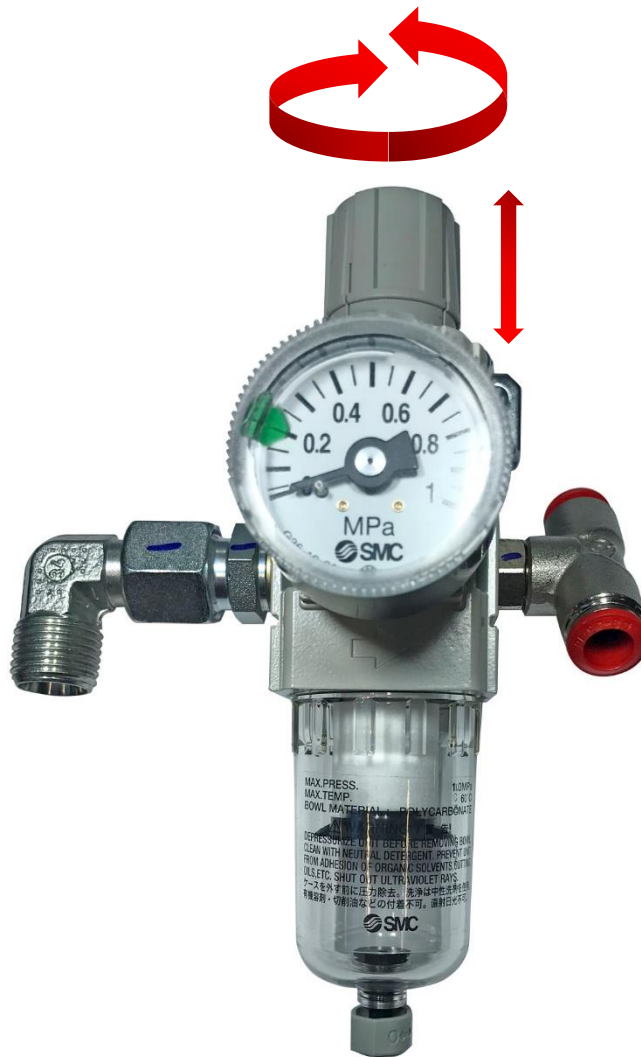

THE PRESSURE MUST ALWAYS BE SET TO 0,2 MPA.

14.6 Tramline markers

- The tramline markers are automatically controlled together with the tramline valves.
- The tramline markers can be deactivated using the ball valve on the rear target holder.

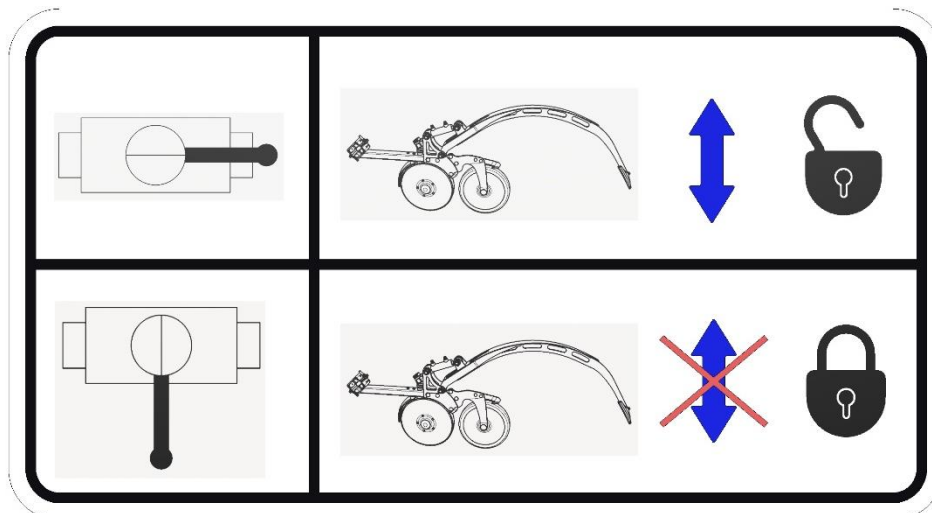

15 Farmet dispenser

- Dispenser with roller change system.

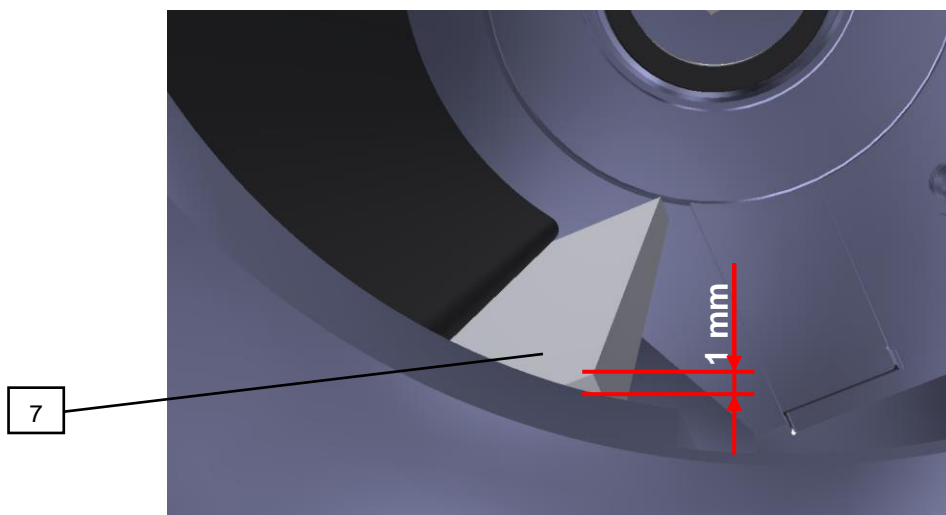
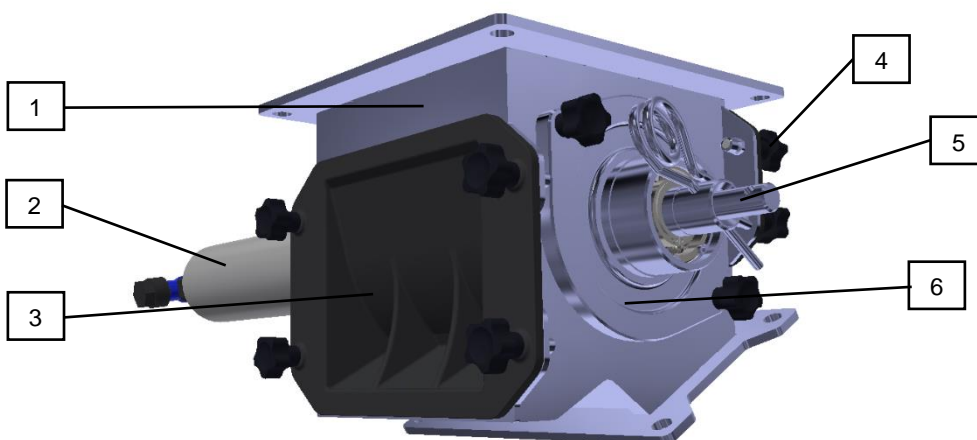

1	Body of Farmet dispenser	5	Dispenser shaft
2	Drive motor	6	Side cover with roller mounting
3	Dispenser front with bottom trowel	7	Lower roller trowel
4	Dispenser front with top trowel		



It is necessary to check both trowels of the dispenser rollers every day before work. Any sign of deformation and loss of trowel material can lead to inaccurate dose requirements. The trowel can be rotated and used from the other side. In case of damage to both sides, we recommend purchasing a new part. **The trowel must extend 1-2mm beyond the edge of the circular opening of the dispenser.**



Before each use while standing, it is necessary to check the cleanliness of the roller and the dispenser. The roller must rotate freely in the metering unit. If dispenser gets stuck, there is a risk of breaking the fuse of the dispenser motor.

15.1 Dispenser function test

1. After installing a new roller, the function, centering and smooth running must be checked.
2. To start the roller, use the metering fill function or the sowing test.
3. The drive motor must run evenly "smoothly".
4. Check clutch centering. If running unevenly, the dosing is inaccurate and the motor can be overloaded.
5. At the point where the roller cuts, repair them, they must be reground or returned.
6. Loosen the screws on the side covers for the drive motor and roller bearing, and realign the side covers to prevent stress.
7. If the drive shaft is bent, it must be aligned or replaced.
8. If foreign bodies are stuck between the roller and the metering housing, they must be removed.
9. If there is dust or mordant in the roller between the metering discs and the spacer roller, disassemble and clean the roller.

15.2 Rough seeds

- For sowing rough seeds (corn, beans, peas, etc.) it is necessary to adjust the metering unit.
- The deflector (1) prevents large seeds from getting stuck between the metering cover and the roller. Failure to install the deflector could damage the roller, metering unit, or motor.
- For very large grains, a large seed adapter (2) can be fitted. This makes it easier for large grains to enter the dispenser and prevents grain damage.
- If necessary, add talc or graphite powder to the seed. Some types of large seeds do not spread well and may not completely fill the roller holes.

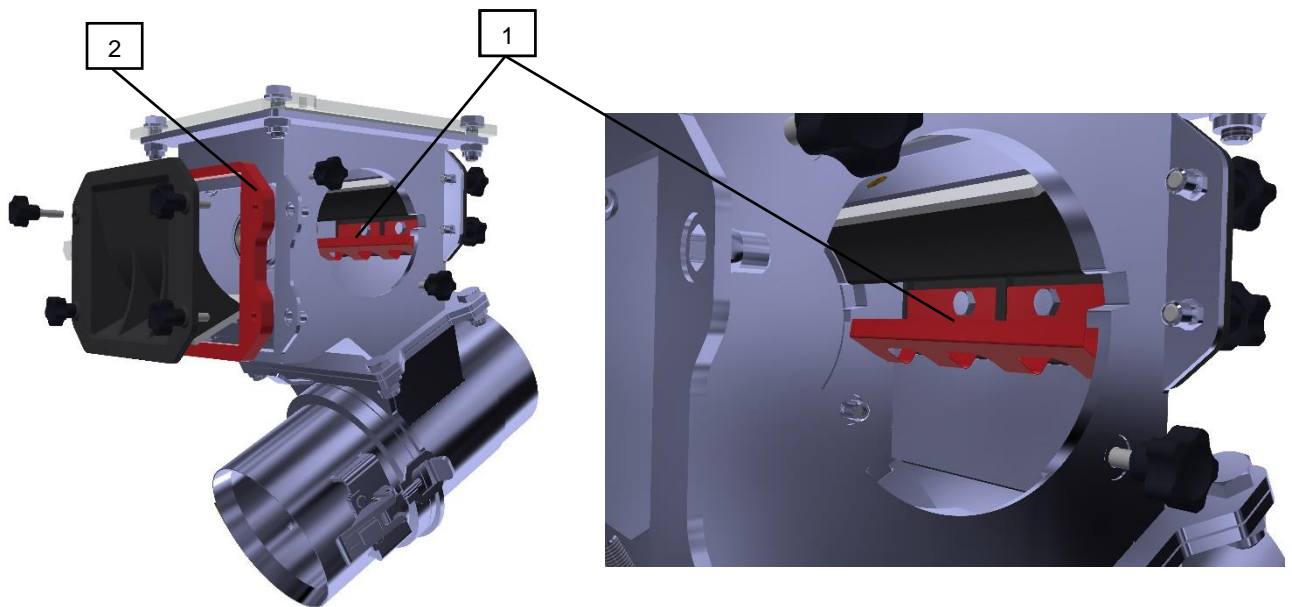

1	Deflector for large seeds	2	Adapter for large seeds
---	---------------------------	---	-------------------------



- When using the adapter for large seeds, it is necessary to use longer fixing screws L= 30mm (accessories of the adapter frame).
- **Deflector set with an adapter for large seeds is part of the machine accessories.**

15.3 Roller replacement

- After selecting the roller according to the table, the roller must be mounted in the metering unit.
 1. With the full hopper, slide the slider over the dispenser (9).
 2. Remove the screws (6) on the side cover of the metering roller (1).
 3. Remove the roller (3) with drive shaft (5) and the side lid (1).
 4. Remove the cotter pin (7).
 5. Remove the secure ring (2) and cover washers (4)
 6. Pull out the shaft (5) roller and mount it on a new roller. Keep the washers (4) on both sides of the roller!
 7. Secure the roller (3) with secure rings (2)
 8. Insert the roller (3) into the dispenser.
 9. Replace the side cover (1) and tighten the screws (6).
 10. Secure with a cotter pin (7) (the first hole on the shaft).
 11. Pull out the slider (8) and secure him to be sure that dispenser seals.

- After each roller change, the trowel settings and the centered operation of the roller must be checked.

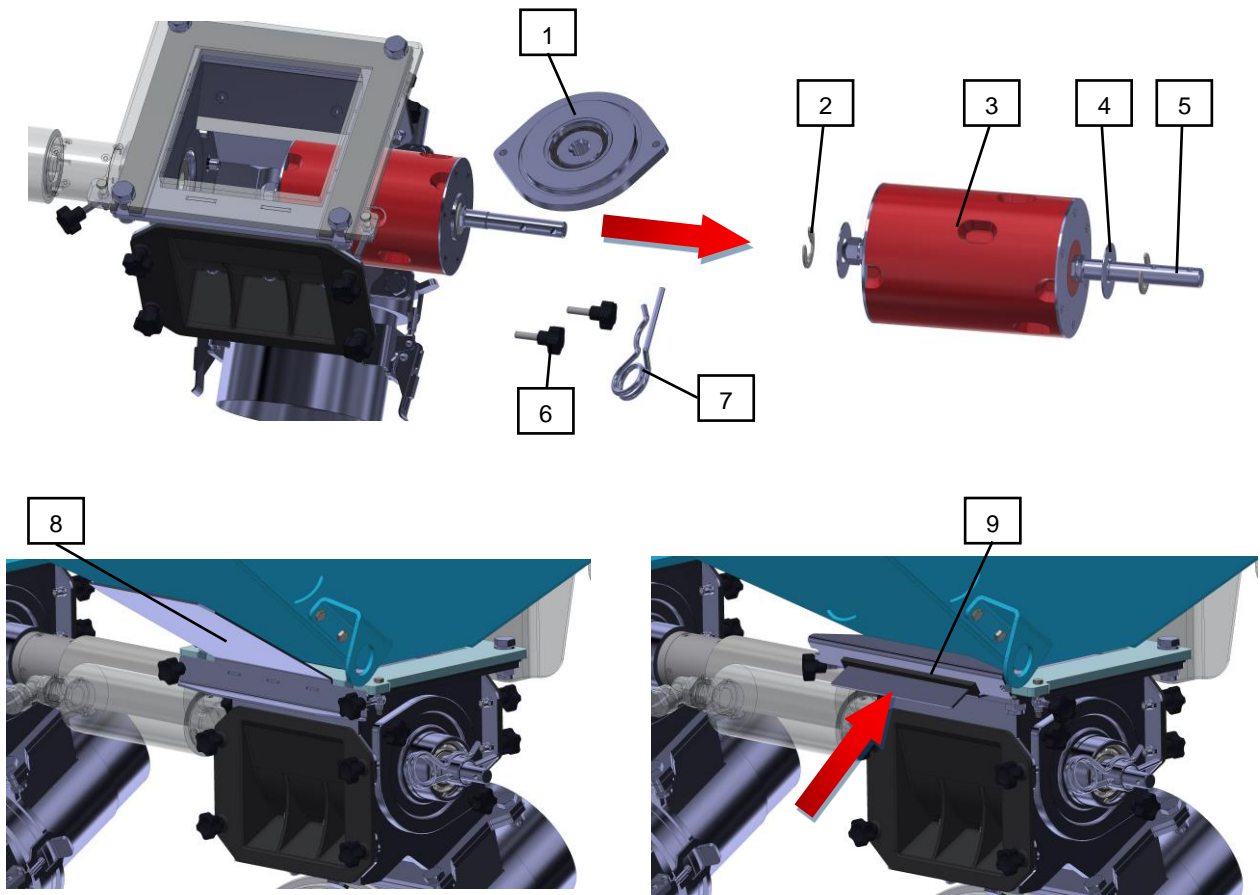

1	Side cover of the dosing roller	6	Screws
2	Secure ring	7	Cotter pin
3	Dosing roller	8	Closing slider in open position
4	Cover pad	9	Closing slider in closed position
5	Dosing roller shaft		

15.4 Rollers for fine seeds

- The fine seed rollers consist of metering discs, spacer rollers and a drive shaft.
- The rollers can be mounted with one or two dosing discs.
- With the two dosing discs on the roller, the spread rate is doubled.
- The dosing disc is available with a dosing volume 3,5 cm³, 9 cm³.
- When sowing, only the metering discs in the roller rotate. The spacer cylinders are blocked stops on the housing.
- When assembling and disassembling the rollers, the screws (2) must be turned into the recess (10) in the dispenser body.

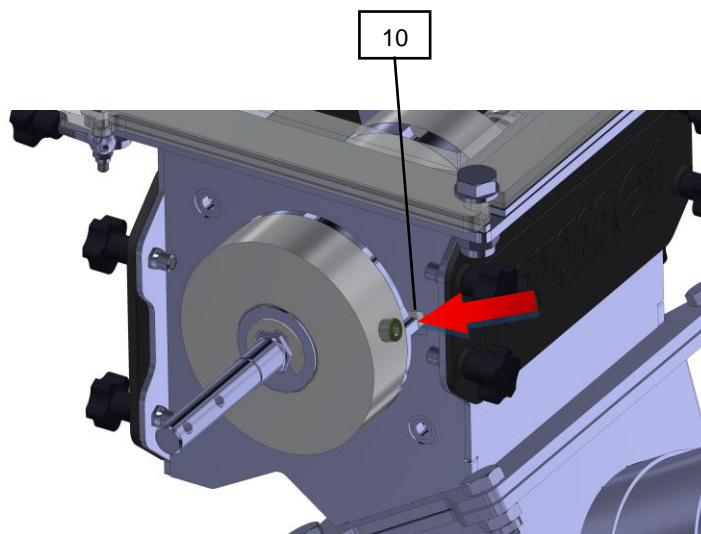
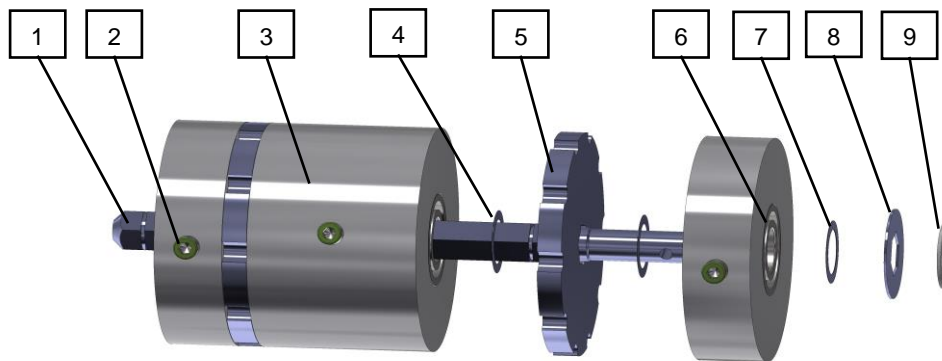

1	Roller shaft	6	Roller bearing
2	Anti-rotation screw (locking screw)	7	Spacer washer 0,2 mm
3	Spacer washer with lock	8	Cover washer 1 mm
4	Spacer washer 0,1mm	9	Secure ring
5	Dosing disc	10	Hole for locking screw (dispenser selection)

16 Sowing test

16.1 Hose distribution type



- Before the sowing test, it is necessary to know the type of hose distribution. *See page 3 for your machine configuration.

Hose distribution type EC

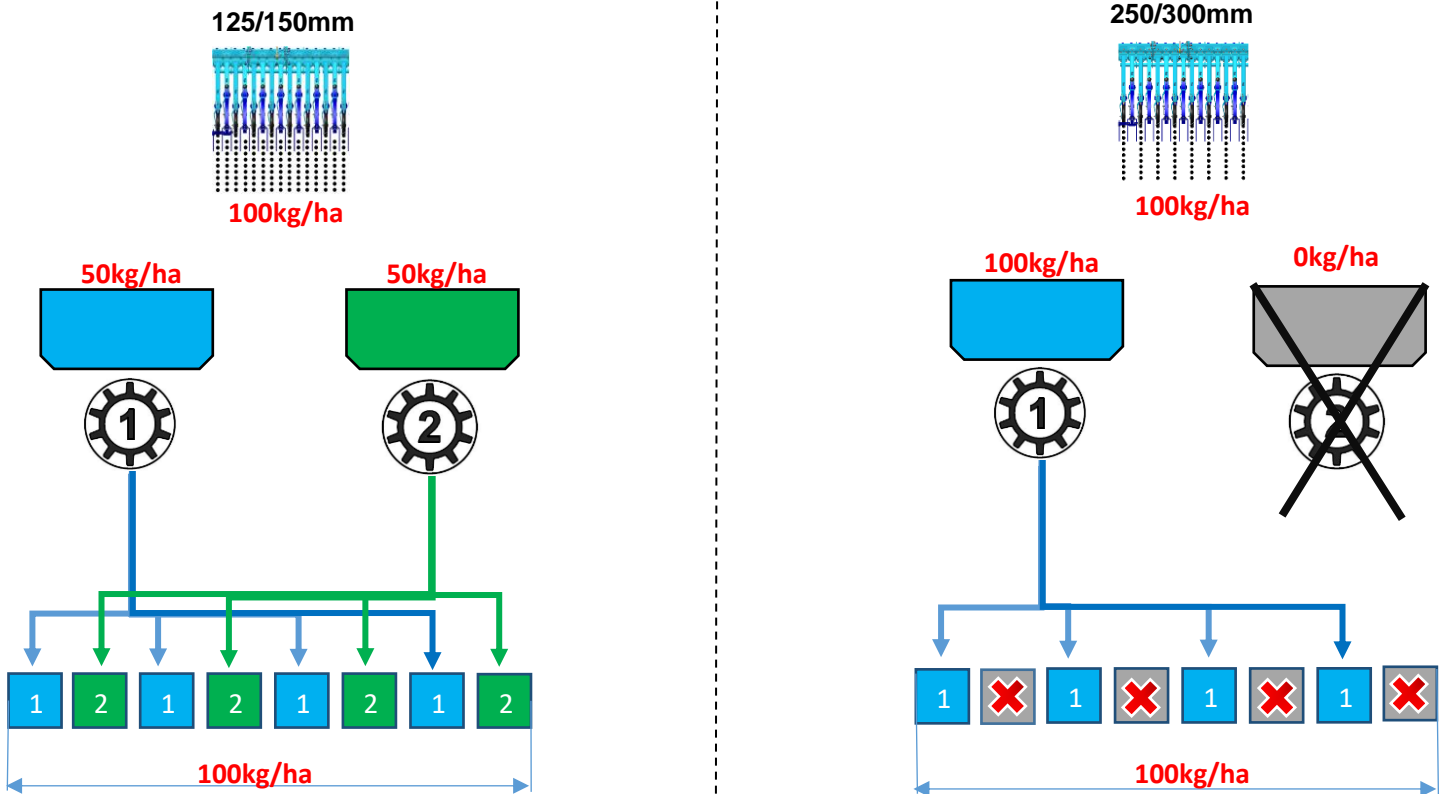

Hose distribution type HM

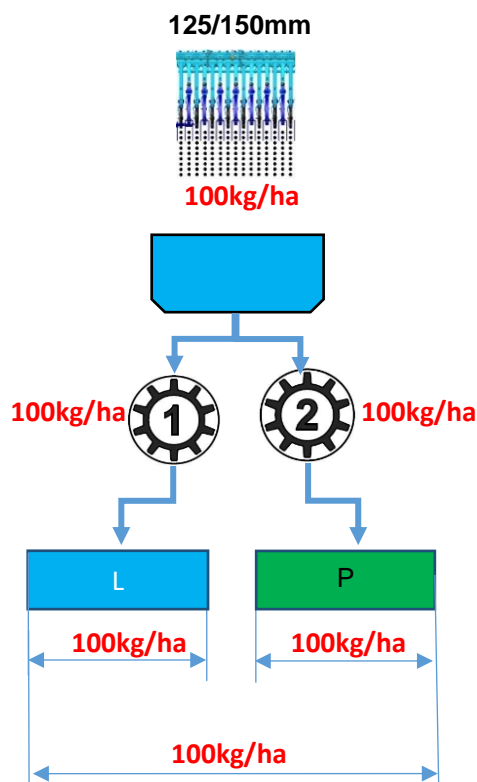

16.2 Sowing test





1. You will need the designated accessories to perform the calibration test.
 - Scale
 - Bucket
 - Sowing table
2. Select the correct roller for the roller metering unit based on the sowing table – page 63.
3. Check the cleanliness of the dispenser, roller and trowel condition.
 - **The trowel must reach on the roller - page 56.**

4.  -Turn on the application

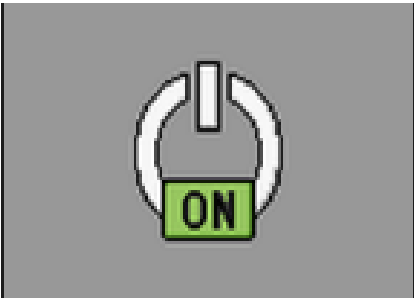
Touch

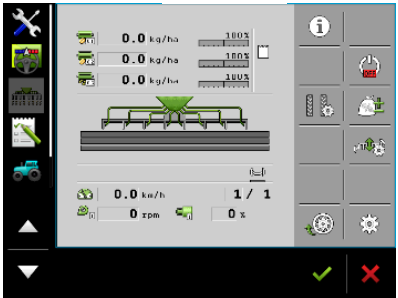

Basic

5.  -Settings.
6. Select the **Product** for which you want to calibrate.
 - Type of hose distribution EC setting up **MOTOR 1 / 2 / 3**.
 - Type hose distribution HM setting up **SEED / FERTILIZER**
7.  -Calibration.
8. Select **Dispenser**, which you want calibrate **1 / 2**.
9. **Mode – method of sowing test**
 - **Manually** (while holding the calibration button, the roller rotates).
 - **Area**
 - **Time** (pre set roller rotation time)
 - **Revolutions**
10. **Working speed – expected speed at working progress.**
 Example: **10km/h**.



11. **Required value – sowing dose**

Example:

One dispenser: Total dispenser requirement 200 kg/ha, set 200 kg/ha.

Split-up EC: Requirement 200 kg/ha, set to each dispenser 100 kg/ha.

Split-up HM: Requirement 200 kg/ha, set to each dispenser 200 kg/ha.

12. **Calibration factor - from the table of calibration factors – page 64.**

Example: **150 g/rev.**

- Calibration factor – number of grams per revolution of the roller.
- The calibration factor from the table is for guidance only. After the sowing test, the calibration factor is automatically recalculated.

13. Hang the calibration bucket.

14. Open the slider.

15.  -Fill the roller.

16. Pay attention to the selected units on the scaling device.

17. Empty the bucket, then hang it on the scale and use the TARE function.

18. Hang the calibration bucket on the dispenser.

19.  -Activate calibration button.

20. Hold down the calibration button. There must be a large amount of seed in the bucket for accurate calibration.

Example: Wheat 4 kg, Rape 0,5 kg

21. After releasing the calibration button, weight the amount of seed in the calibration bucket.

22. Enter the weight into the terminal. For this entry use a window with the name **Acquired value**.

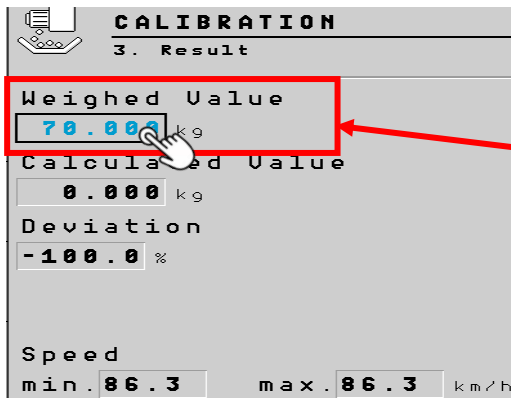

Rewrite the value



23. Check that you are comfortable with minimum and maximum **speed**.

- If it does **NOT COMPLY**, replace the roller and repeat the test.
- Minimum speed is too high= select a smaller roller (**ideal speed is from 1,5km/h**).
- Maximum speed is too low= select a larger roller.
- **Deviation** – For a roller dispenser should not be greater than 1 %, for auger metering unit 5 %.

- **If the deviation is too large, confirm the calibration**



and repeat it again from







point 17.



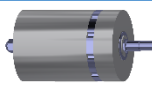
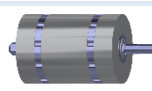
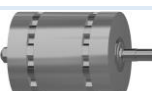

the calibration

24. Repeat the same calibration procedure for the other dispenser. **Working speed range of electric motors is 15-100% (you will find this value on the work screen).**

16.3 Sowing tables for FARMET dispenser

Roller		Machine grip		3m		4m		6m		8m		9m		Crop
		Number of dispensers		1	2	1	2	1	2	1	2	1	2	
V3,5		5-15 km/h	kg/ha min	0,9	1,8	0,7	1,4	0,5	0,9	0,3	0,7	0,3	0,6	Rape, mustard, grass, etc.
			kg/ha max	3,6	7,2	2,7	5,4	1,8	3,6	1,4	2,7	1,2	2,4	
V7		5-15 km/h	kg/ha min	1,8	3,6	1,4	2,7	0,9	1,8	0,7	1,4	0,6	1,2	Rape, mustard, grass, etc.
			kg/ha max	7,2	14,4	5,4	10,8	3,6	7,2	2,7	5,4	2,4	4,8	
V18		5-15 km/h	kg/ha min	5,5	11	4	8	3	5,5	2	4	1,8	3,5	Mustard, grass
			kg/ha max	22	43	14,5	32	11	21,5	8	16	7	14,5	
V20		5-15 km/h	kg/ha min	6	12	4,5	9	3	6	2,3	4,5	2	4	Corn
			kg/ha max	24	48	18	36	12	24	9	18	8	16	
V40		5-15 km/h	kg/ha min	13	26	10	20	7	13	5	10	4	9	Grain, corn, spelled without chaff
			kg/ha max	50	100	38	75	25	50	19	38	17	33	
V100		5-15 km/h	kg/ha min	30	60	23	45	15	30	11	23	10	20	Grain, corn, spelled without chaff
			kg/ha max	120	240	90	180	60	120	45	90	40	80	
V250		5-15 km/h	kg/ha min	75	150	56	113	38	75	28	56	25	50	Grain, corn, peas, broad beans, soybeans, spelled with chaff, sunflower
			kg/ha max	300	600	225	450	150	300	113	225	100	200	
V500		5-15 km/h	kg/ha min	150	300	113	225	75	150	56	113	50	100	Grain, corn, peas, broad beans, soybeans, spelled with chaff, sunflowers, solid fertilizers
			kg/ha max	600	1200	450	900	300	600	225	450	200	400	

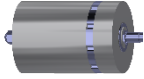
CALIBRATION FACTOR TABLE OF FARMET DISPENSER ROLLER

SPECIES		WHEAT	PEA	BARLEY	OAT	PEA	CORN	MUSTARD	RAPE	POPPY	LUCERNE	GRASS	BINDING
ROLLER	Cm ³ /rpm	g/cm ³											
		0,77	0,74	0,68	0,5	0,81	0,79	0,6	0,65	0,4	0,8	0,36	0,22
V3,5	 3,5							2	2	1	3	1	1
V7	 7							4	5	3	6	3	2
V18	 18							10				8	5
V20	 20						16						
V40	 40	31	30	27	20	32	32						
V100	 100	77	74	68	50	81	79						
V250	 250	193	185	170	125	203	198						
V500	 500	385	370	340	250	405	500						



NOTE: The calibration factors in this table are for guidance only. After the calibration test, the calibration factor is automatically recalculated.

17 Settings of seed section

- For optimum seed placement must be observed the following parameters:
 1. Required sowing depth
 2. The amount of pressure

17.1 Sowing depth setting

- The sowing depth is set using the pin (2), which is adjusted in the holes of the setting link (1).
- Each hole corresponds to a certain sowing depth. This only applies when the machine is level.

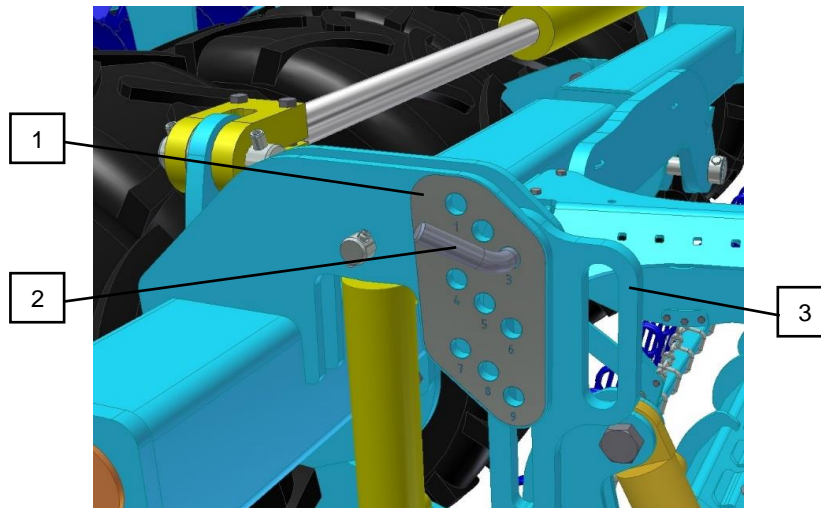

1	Metal plate with scale from 1 to 9
2	Depth adjustment pin
3	The pull of the backdrop

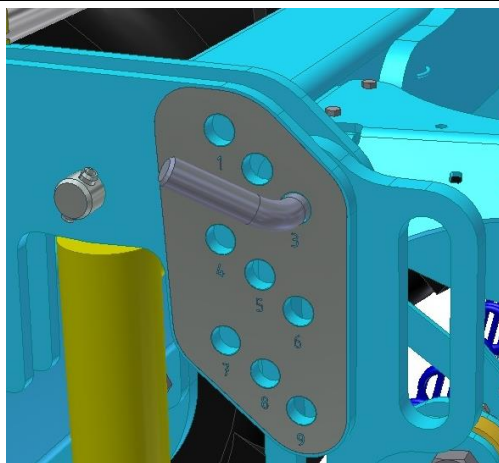

1	Sowing depth 1 cm	5	Sowing depth 5 cm
2	Sowing depth 2 cm	6	Sowing depth 6 cm
3	Sowing depth 3 cm	7	Sowing depth 7 cm
4	Sowing depth 4 cm	8	Sowing depth 8 cm
9	Sowing depth 9 cm		



The values in the table are for guidance only, they may vary according to soil conditions.

17.1.1 Recommended depth



- The setting of the sowing depth and the coulter pressure interact.
- After each sowing depth change, drive a few meters and check the seed placement depth and the coulter pressure.

Species	Recommended sowing depth	Recommended sowing rate
Spring wheat	4-5 cm	220 kg
Spring triticale	4 cm	200 kg
Spring barley	3-5 cm	200 kg
Oat	3-5 cm	200 kg
Corn	5-8 cm	20-70 kg
Buckwheat	3-5 cm	70 kg
Peas	4-6 cm	250-300 kg
Spring weasel	4-6 cm	120-180 kg
Broad bean	6 cm	180-250 kg
White lupine	6-8 cm	160-180 kg
Spring rape	2-3 cm	3-6 kg
White mustard	2-3 cm	8-10 kg
Poppy seeds	1-2 cm	1 kg
Sunflower	4-6 cm	4-25 kg
Meadow clover	1-2 cm	15-20 kg
Lucerne	1-2 cm	8-16 kg

17.2 Sowing section pressure setting

DEPTH [cm]	PRESSURE [kg]	
	LIGHT / SANDY SOILS	HEAVY / CLAY SOILS
1	35	60
2	45	70
3	55	80
4	65	90
5	70	100
6	80	110
7	90	115
8	100	120



- These are indicative recommended values. The correct pressure for a given specific condition may be different and must be adjusted accordingly. In case of dry weather, we recommended increasing the pressure.



- Check the seed placement depth in the field after each change of coulter pressure or sowing depth.
 1. Lower the machine to the working position, drive a few meters.
 2. Check the required seed placement depth and seedbed compaction.

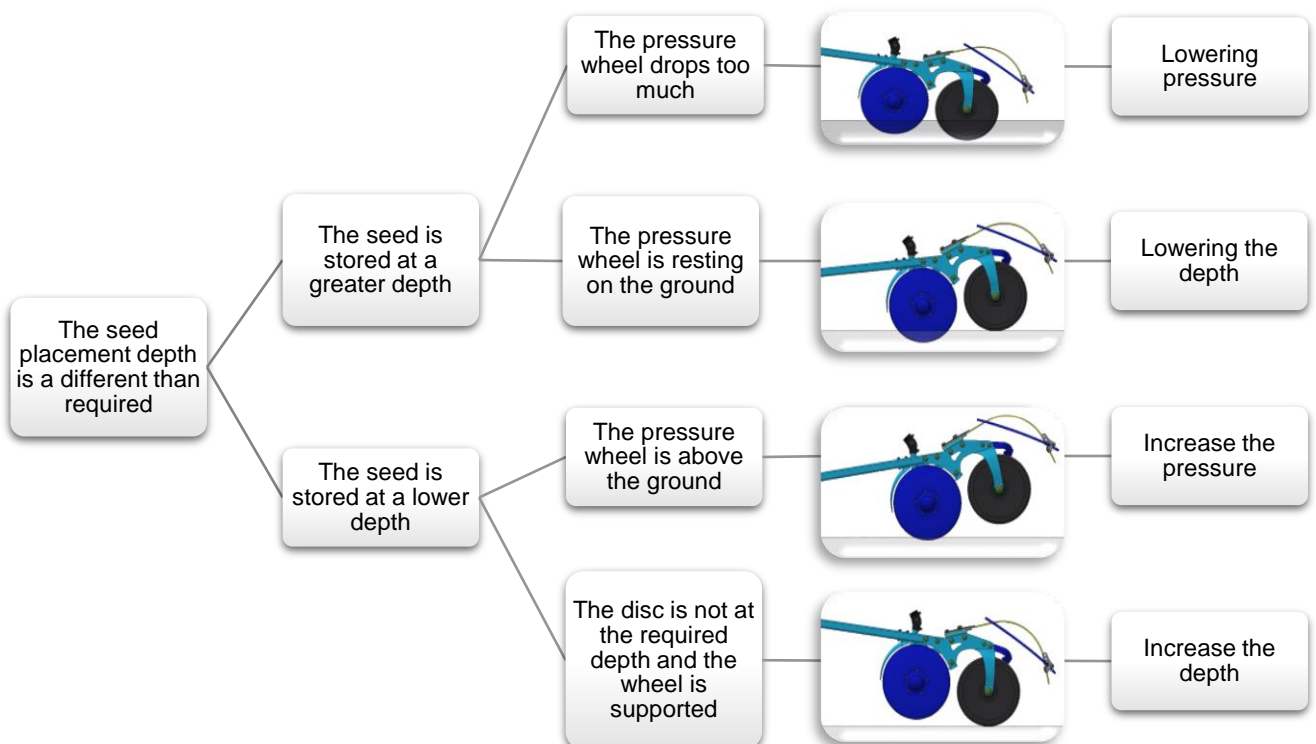





- If the machine is raised, the pressure is too high = lower the pressure.
- The pressure must always be set according to the soil conditions.
- If the pressure is too low, the sowing depth may be unevenly distributed.

17.2.1 Increase the pressure

1. Apply pressure to  and leave it closed.
2. Use the wheel to gradually tighten the pressure reducing valve to increase the coulter pressure.
3. Again drive a few meters and check the seed placement depth.

17.2.2 Lowering the pressure

1. For lowering the pressure, raise the seed section to the upper position with  .
2. Releasing the pressure reducing valve reduces the pressure.
3. Lower the sowing section to the working position with .
4. Check the reduced pressure on the manometer.
5. Again drive a few meters and check the seed placement depth.



17.3 Seed coulters

Description of the seed coulters

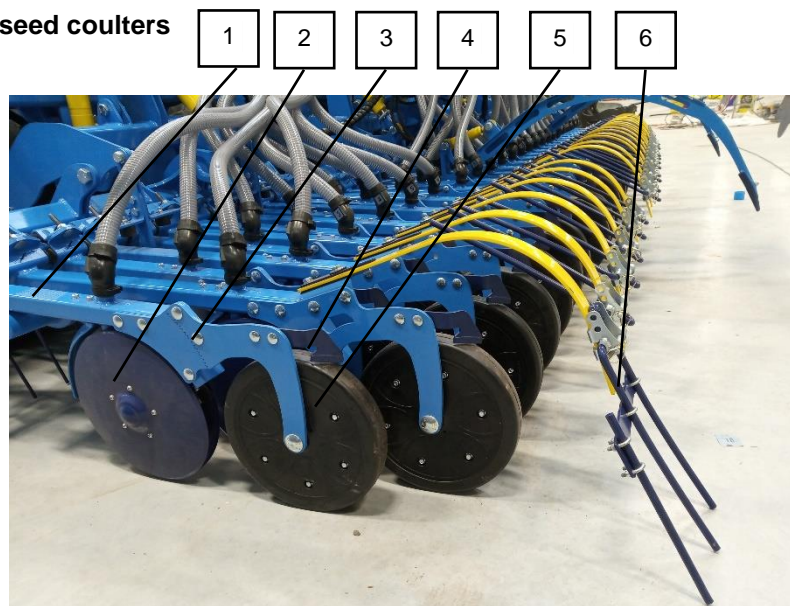

1	Seed coulter frame	4	Pressure wheel scraper
2	Coulter discs	5	Pressure wheel
3	Comb of the wheel	6	Harrow

- The seed is sown with the coulters.
- The coulter discs (2) cut through the seedbed and expose the seed groove.
- The seed is stored between the discs (2).
- The pressure wheel (5) guides the seed coulter and closes the groove.
- The harrow (6) covers the sowing row with soil and levels the soil.
- The coulter is stored in maintenance-free rubber bearings.

Coulter discs

- The discs are located at the front, are V-shaped for each other for low tensile strength and the formation of a groove for seed placement.

Disk adjustment

- In case of wear the seed discs, it is necessary to adjust the distance between the discs by changing the location of the spacers.
- All 4 spacers (1) must always be used on each coulter. If all 4 spacers (1) are not used – **the coulter will be damaged**.
- The discs must be slightly pretensioned on the blade. However, it must be possible to turn them easily.
- When rotating one disc, the other must be rotated reliably.
- If the discs stop or lock due to incorrect preload, the seed will start to aggregate.

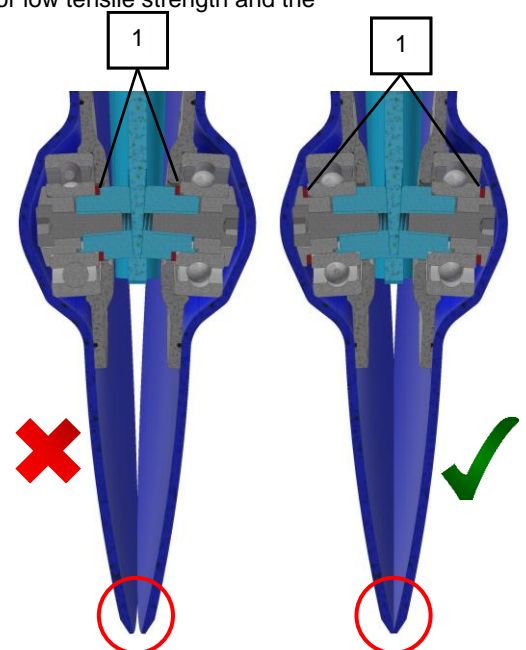

17.3.1 Disc and pressure wheel trowels

- The trowels remove dirt from the discs and pressure wheels.
- Regularly check the function and wear of the trowels.

Disc trowels

- The trowel has a carbide tip the edges.
- Make sure that the entire trowel rests evenly on the surface of the disc.

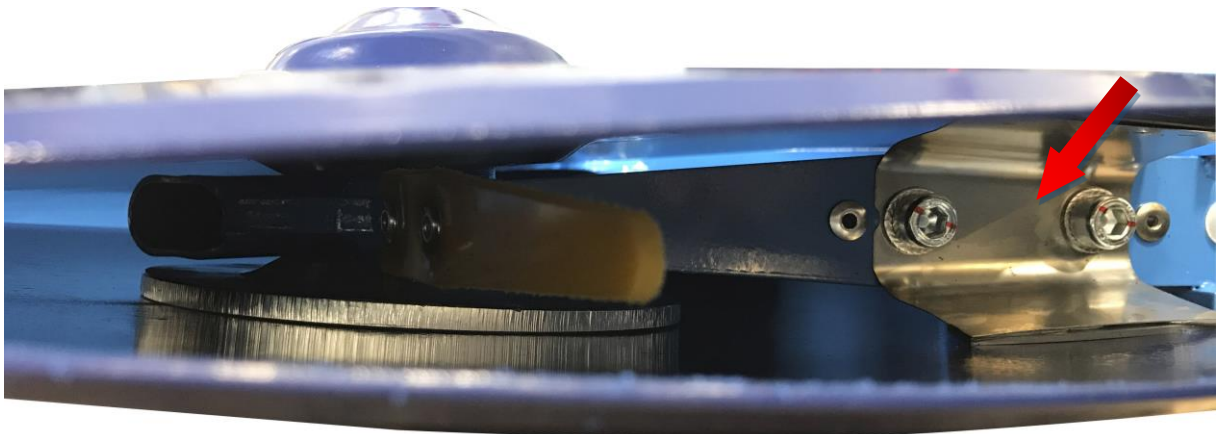

Pressure wheel scraper

- The distance of the scraper from the wheel must be 1-2 mm.

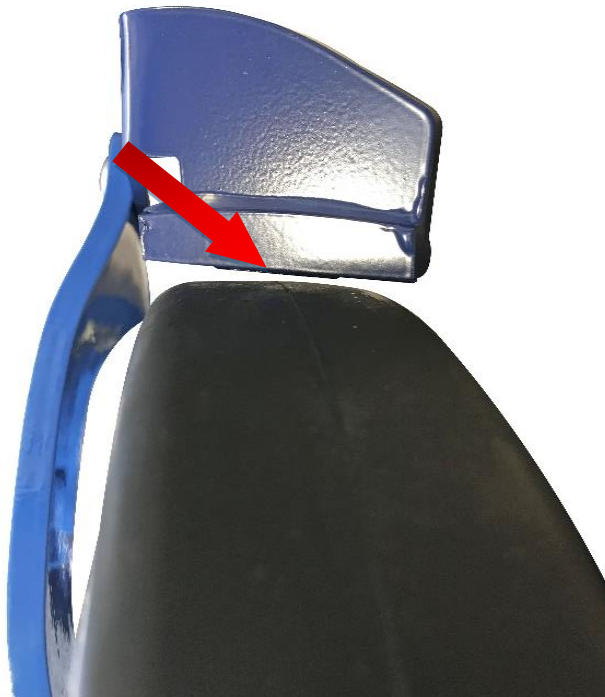

17.3.2 Pressure wheel

- The pressure wheels provide depth guidance when sowing the seed, cover the seed with fine soil and press it against the seed.
- To sow all coulters to the same depth, it is necessary to have the wheels set in the same position.

Settings

- For each short coulters, it is possible to adjust the position of the pressure wheel relative to the coulters disc.
- If you want to have a different sowing depth between neighbour rows you must change the position of the link wheel.

Example: On seed coulters with adjustable pressure wheels (short) it is possible to adjust the sowing depth to the long seed coulters (6 cm long, short 4)

Wheel reset procedure

- Loosen the screws (2).
- Let's readjust the comb (1) by the required value.
- Tighten the screws (2).

Teeth on a comb	cm
2	1
4	2
6	3

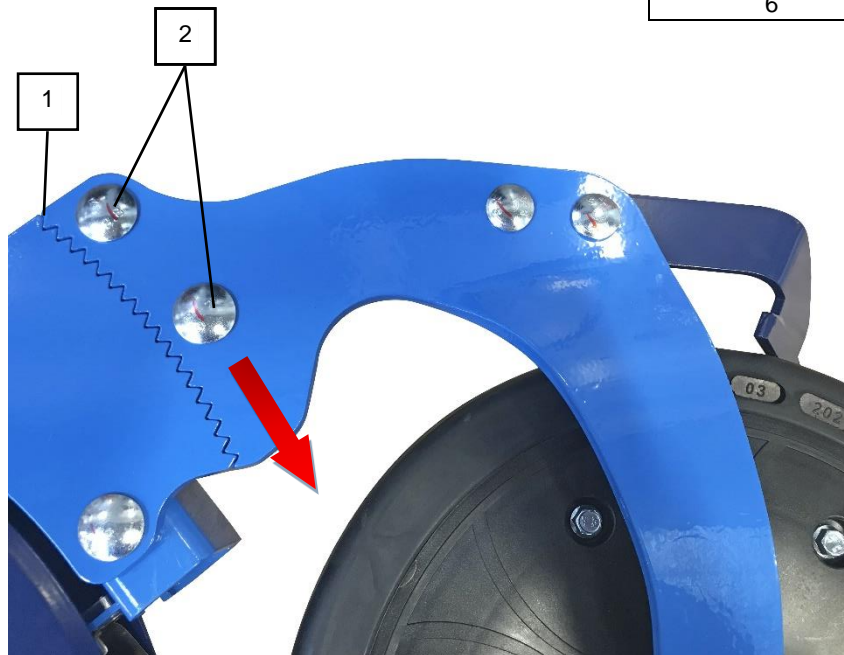

1	Comb wheels	2	Screws
---	-------------	---	--------

17.3.3 Harrows

- It is possible to change the aggressiveness of the harrows by adjusting the pin. With a large amount of crop residues, harrows can be discarded (1).

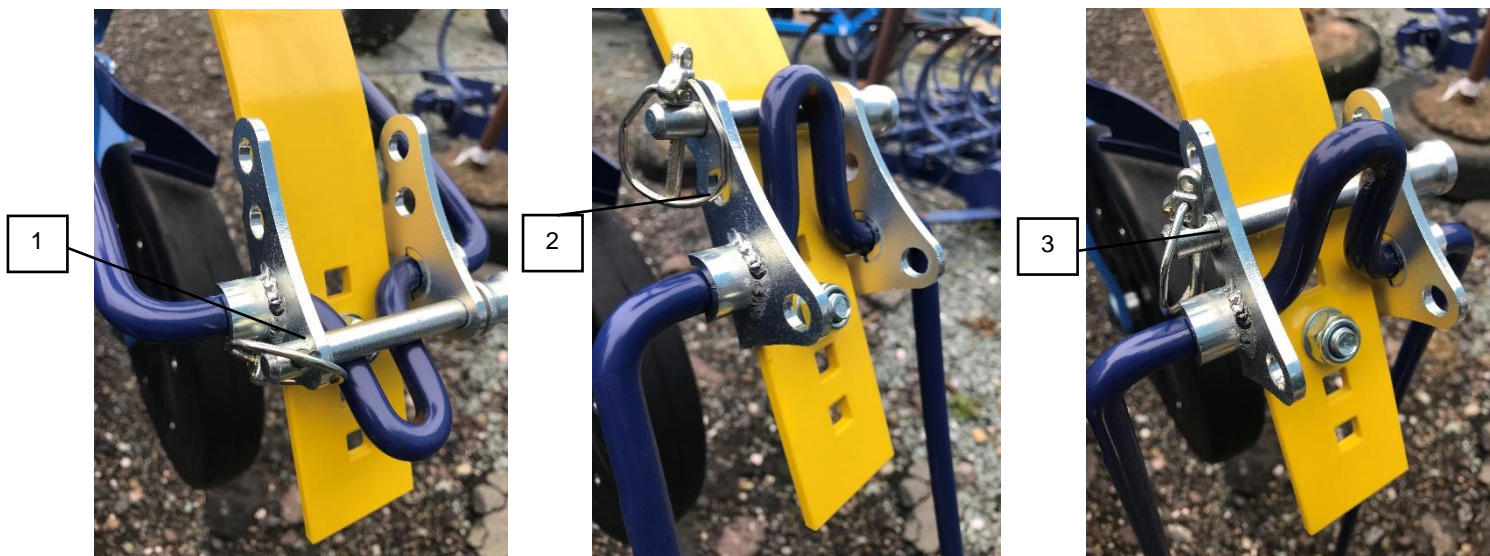

1	Discarded harrow
2	The first degree of aggression of the harrow
3	The second degree of aggression of the harrow



The cotter pin must always be fully secured.



18 Adjustin the dose during work

This function is used to adjust the target dose (100%) to a dose in the range of +/-100%, if the engine allows to use in this range.



-Turn on the application

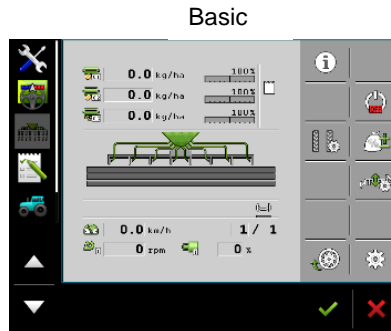

Function icon	Meaning
	Increase the target dose. The target value is increased by a defined value in the product database.
	Reduces the target dose.
	Restores the target dose to 100%.

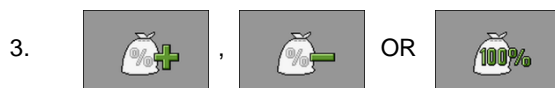
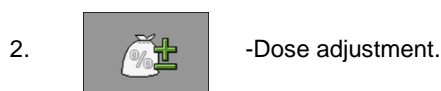

4. On the work screen, the change is shown as follows

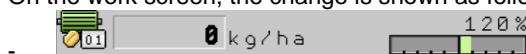

- The control unit recalculates the target dose.
- After one minute of working with the changed target dose, the change indicator starts flashing.

19 Emptying the hopper using electronics

- The system allows the hopper to be emptied using electric or hydraulic motors and calculates the residual quantity.

- 

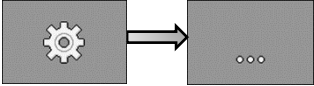
-Turn on the application
- 

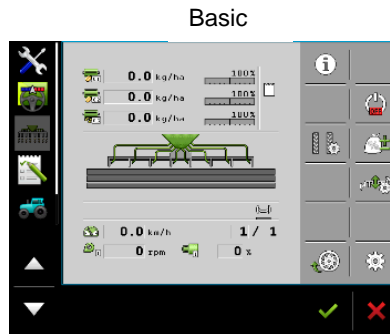

- It is necessary to have a selected container that we want to empty.

- **Hopper**
- **1 / 2 / 3** 



- 
- Confirm **Dispenser**.

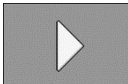

- 

- The calibration buttons are currently used to empty the hopper. When using the emptying function with a hydraulic motor, it is necessary to have an activated circuit for the hydraulic motor.

- When the hopper is empty, press the button  .

20 Working position source

- To switch the sowing on and off, the machine must have information on the working position. In the system it is possible to set which source of working position the system of the machine will use.

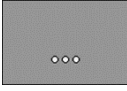
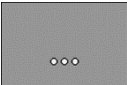
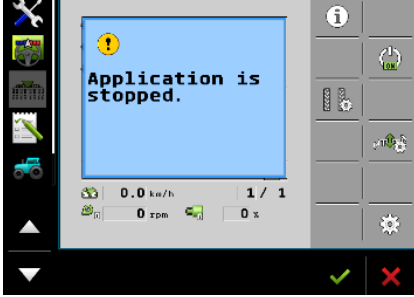
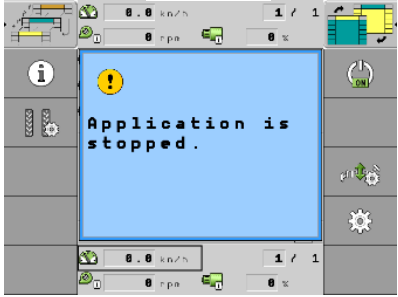
<ol style="list-style-type: none"> 1.  Switch off application 2.  -Settings. 3.  -Go to the next page. 4.  -Go to the next page. 	<p>Touch</p> 	<p>Basic</p> 
--	---	--

5. **Working position**

- **Working position sensor 1** – The source is the machines antenna sensor (default setting) 
- **Tractor** – The source is the working position from the sensor (CAN) of the tractor, eg tractor arms, GPS
- **No / Always in working position** – the machine is constantly in the working position (deepen)

6. After selecting your selected source, use to return to the work screen



21 Source speed machinery

1.  Turn off the application

Touch



Basic



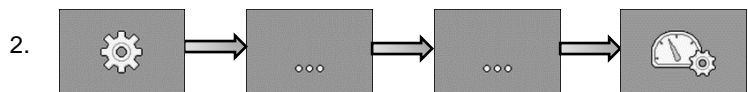

There are 3 options of the travel speed source:

- 1) **Tractor** – The source of speed is the tractor. The machine must be connected to the ISOBUS or CAN of the tractor.



- 2) **Work equipment** – The source of speed is radar or speed GPS directly on the machine.



If the machine is equipped with **radar**, set the number of pulses to - 13 500 to 100 meters.

If the machine is equipped with GPS (speed), set the number of pulses to - 13 000 to 100 meters.

- 3) **Simulation** – this setting is used to simulate a constant speed (use for service purposes)



22 Machine geometry

- This setting is used to define the geometry of the machine relative to the tractor. It is also possible to set the advance and delay of the engine start (sowing).

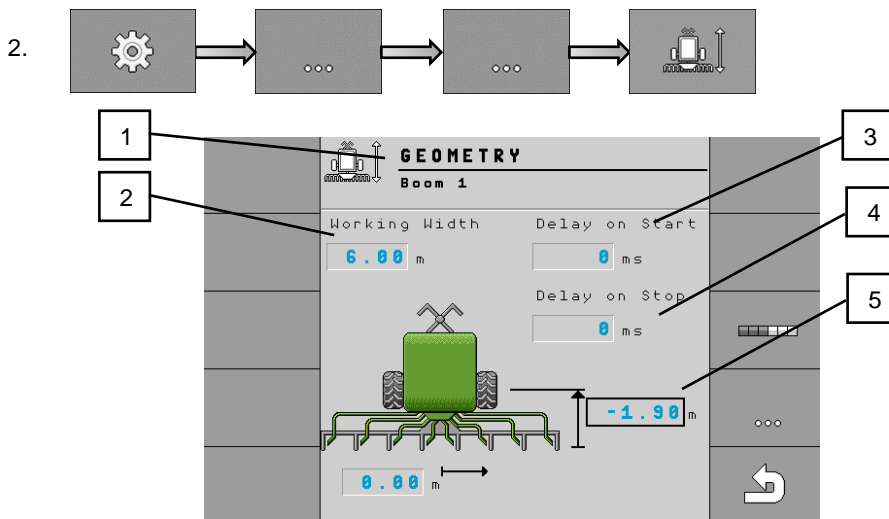
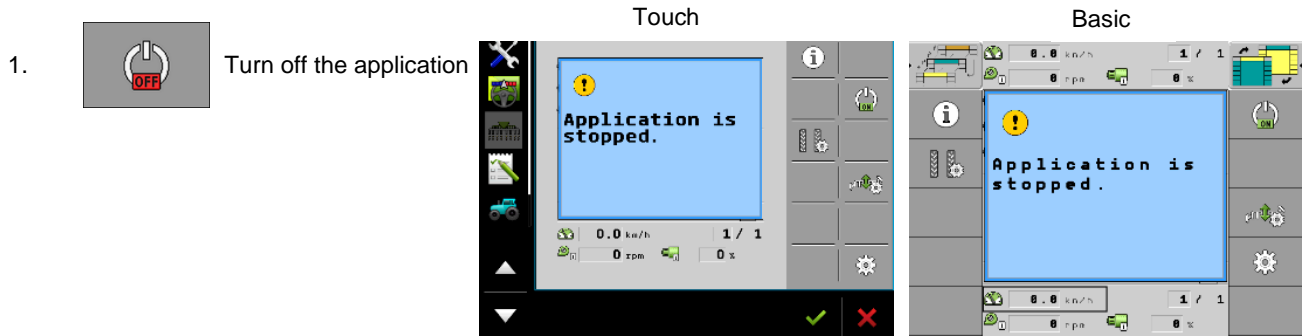

Note on the point 5: If the section is behind the axle axis, the value must always be negative (sowing section), if the section is in front of the axle, the value must be positive (fertilization section).

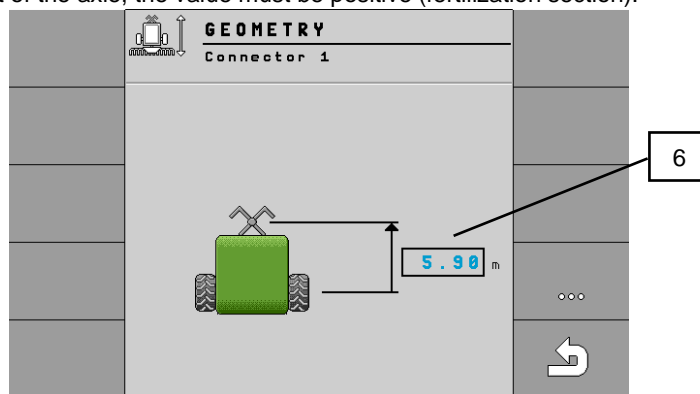

The button is used to move to the setting of arm 2,3 and connection 1



1	Setting of the hopper 1 (motor 1)	4	Advance engine shutdown 1
2	Working width of the hopper 1 (motor 1)	5	Distance from the axle axis to the seed outlet
3	Engine start time 1	6	Distance from the drawbar pin to the axle axis

Use the back button to return from the geometry settings



23 Machine lighting

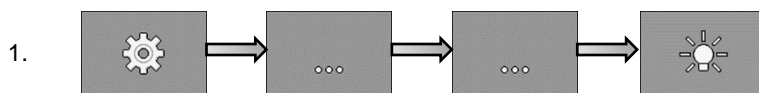

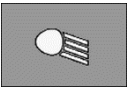
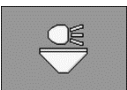
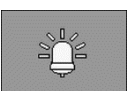
Function icon	Meaning
	Switching work lights on and off.
	Switching the hopper lighting on and off.
	Switching the beacon on and off.

2. After activating your selected function, use to return to the work screen.



24 Controlling sections manually (Section control)

- You can switch sections of your tool using the section control.
- The size of the respective sections that you can switch depends on the type of machine and equipment.
- On the work screen you can see which sections are on and off.

1.  -Turn on the application

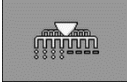
2.  -Controlling the sections

Touch



Basic

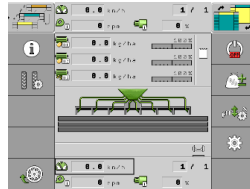

Function icon	Meaning
	Switching the left half of the machine on and off (motor 1).
	Switching the right half of the machine on and off (motor 2).
	Switching off sections from the left side.
	Switching sections from right to left.
	Switching off sections from the right side.
	Switching sections from left to right.
	Moves the cursor from left to right on the work screen.
	Moves the cursor from right to left on the work screen.
	Indicates the part / line that was selected by the cursor for shutdown. Turns on the marked, off section / line.
	Turns all marked sections / lines on or off.
	Turns everything on.

25 Adjusting the harrow behind the roller

- Used to spread plant residues in front of the seed coulters.
- For aggression, its aggressiveness can be set.
- The aggressiveness is set using the pin (2), which is adjusted in the holes of the adjusting link (3). It there is a few post-harvested residues in the field, this harrow is set to a steep position, on the contrary, if there are many post-harvested residues in the field such as sowing corn the harrow must be placed to prevent clogging.
- The cultivator only works with its weight and its automatically raised together with the coulters.

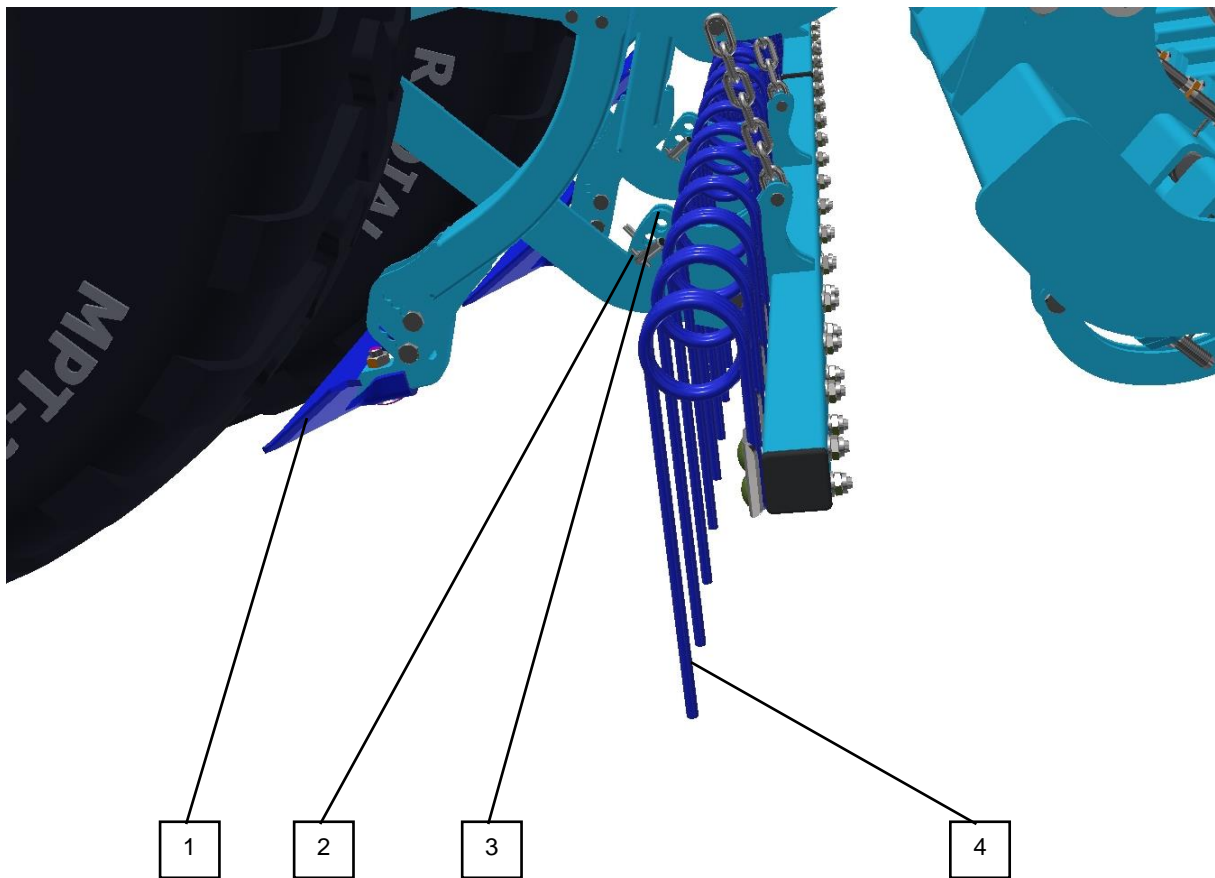

1	Wheel scraper
2	Harrow tilt adjustment pin
3	Setting backdrop for changing aggression
4	Harrowing pen

26 Adjusting the depth of the front preparation section

- The front preparation sections are controlled with help  and an open ball valve.

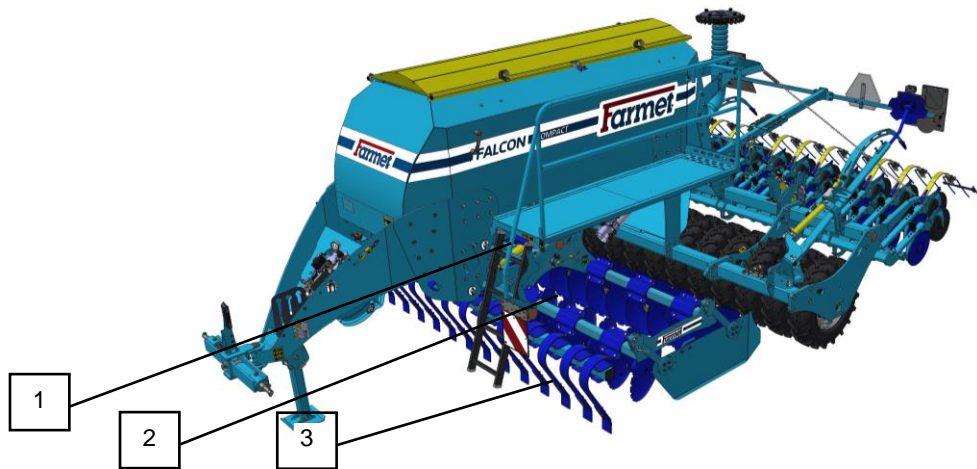

1	Piston rod for section depth adjustment
2	Front preparation section (disc)
3	Flexi board section

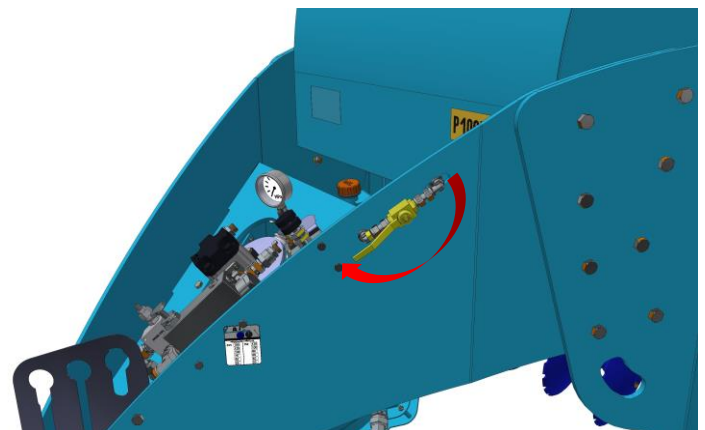
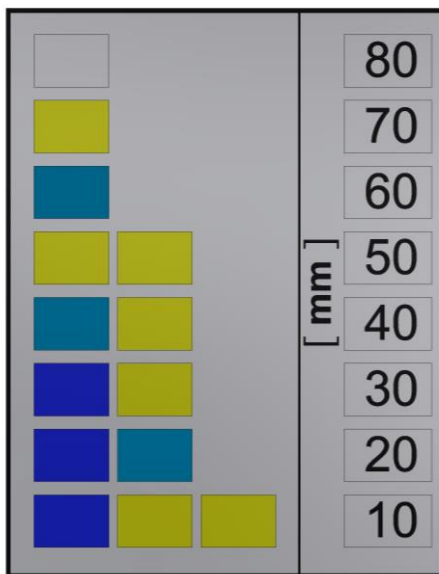

The red clip at the disc section must never be removed. The section is not dimensioned to a depth of more than 80mm and there is a risk of damage!

26.1 Side deflectors of the front preparation section

- Side deflectors prevent the soil from being ejected through the working width of the machine and level the soil wall created by the external discs.

Settings

- The settings must be adapted to the soil conditions.
- No ramparts or furrows may be created between rides.

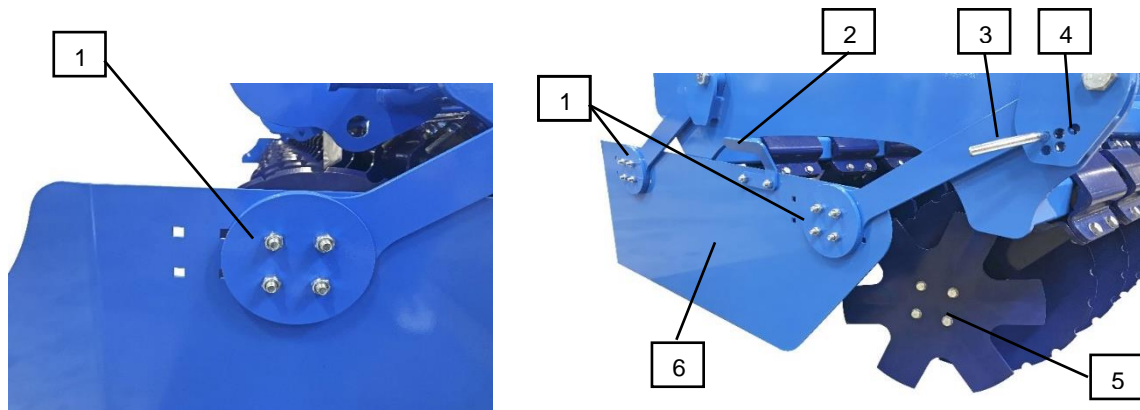

1	Possibility of adjustment in the horizontal direction
2	Deflector handle
3	Deflector depth adjustment pin
4	Backdrop for deflector depth adjustment
5	Star disc
6	Deflector

26.2 Tractor track cultivators

All Falcon machines with a disc pre-processing section are equipped with tractor track cultivator to loosen the tractor tracks.

Depth setting of cultivators:

- Loosen the screws (1).
- Adjust the depth of the cultivators using the holes (2).
- Tighten the screws (1).

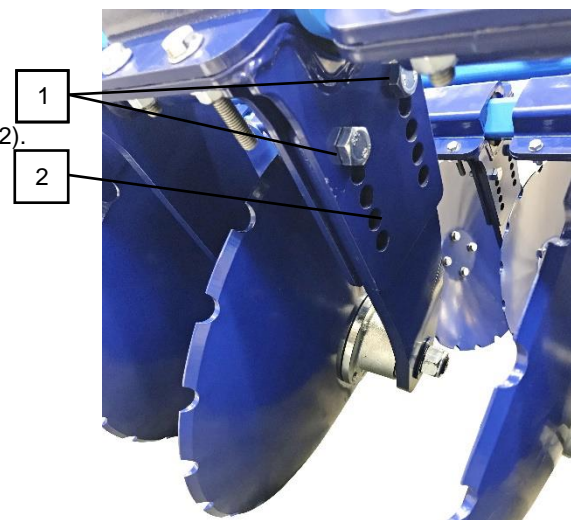

1	Screws
2	Holes for setting the loosening depth

26.3 Flexiboard

- Flexi boards are controlled with help .
- It is used to level plowed soils and a lot of lumpy terrain.
- Before the first use, it is always necessary to pressurize the flexi board to the end position to ensure the uniformity of all its sections.
- It is possible to change its depth directly from the tractor cab according to the current conditions.
- The use of a flexi board is not recommended when sowing in mulch.

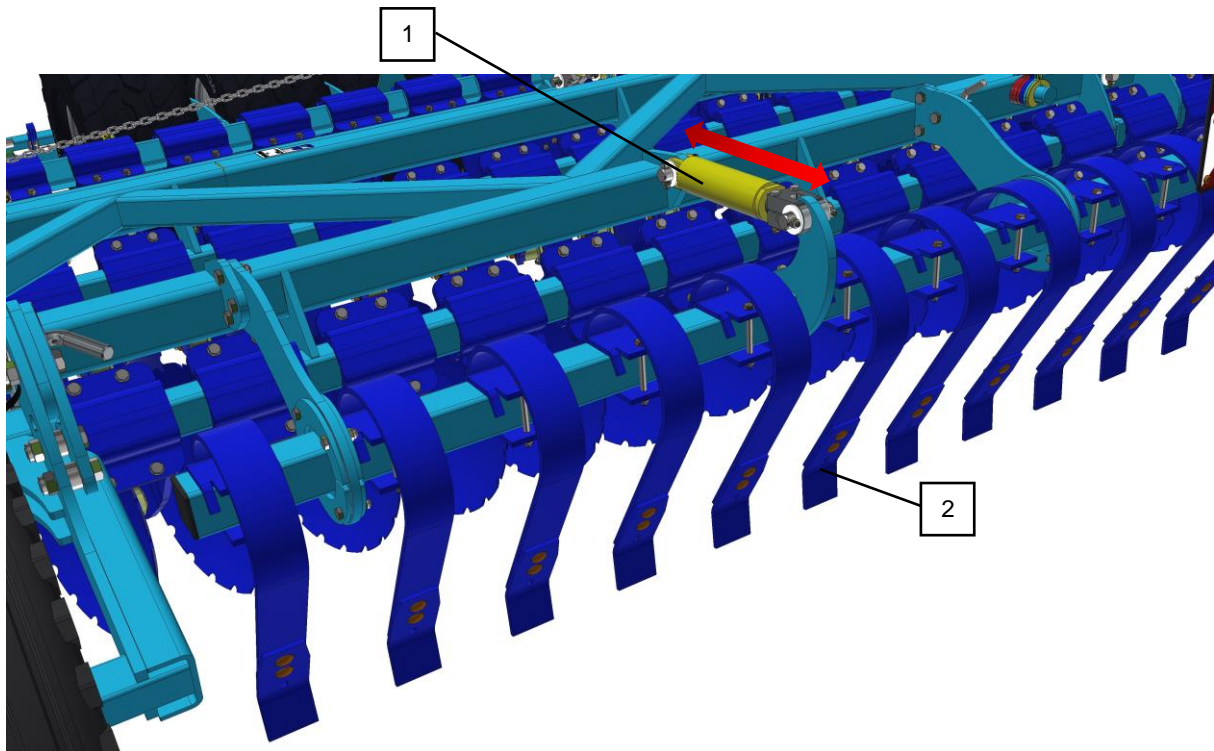

1	Flexi board piston rod	2	Flexi board working body
---	------------------------	---	--------------------------

27 Sowing section shift

- Possibility of moving the seed coulters to the same spacing as the fertilizer section (sowing with every other seed coulters, the seed is stored in the same line as the fertilizer section).
- 1. Sowing STANDARD, fertilization in the interline.

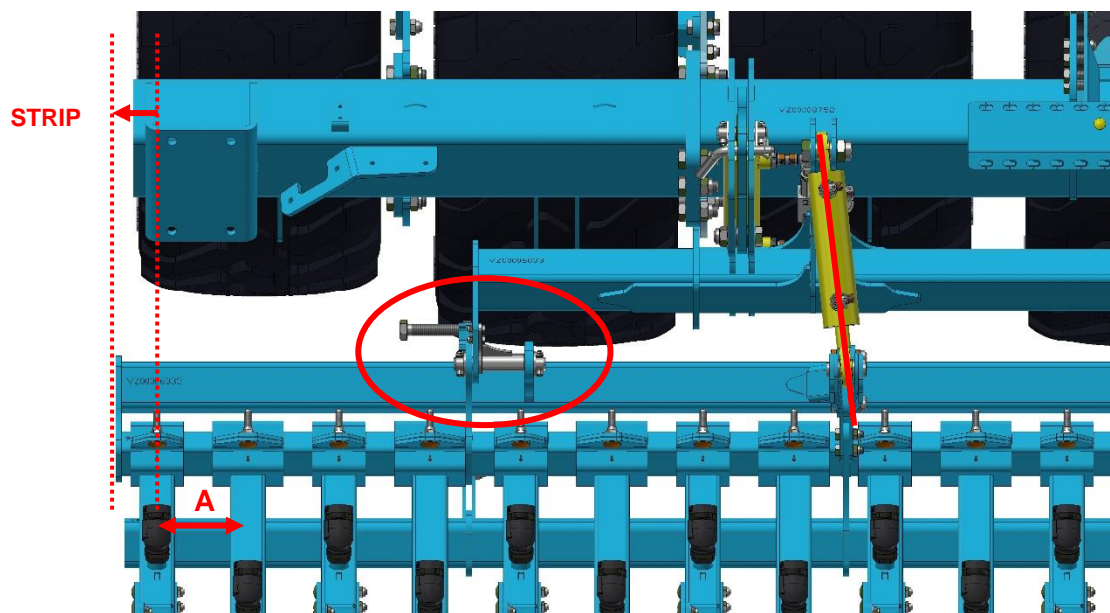
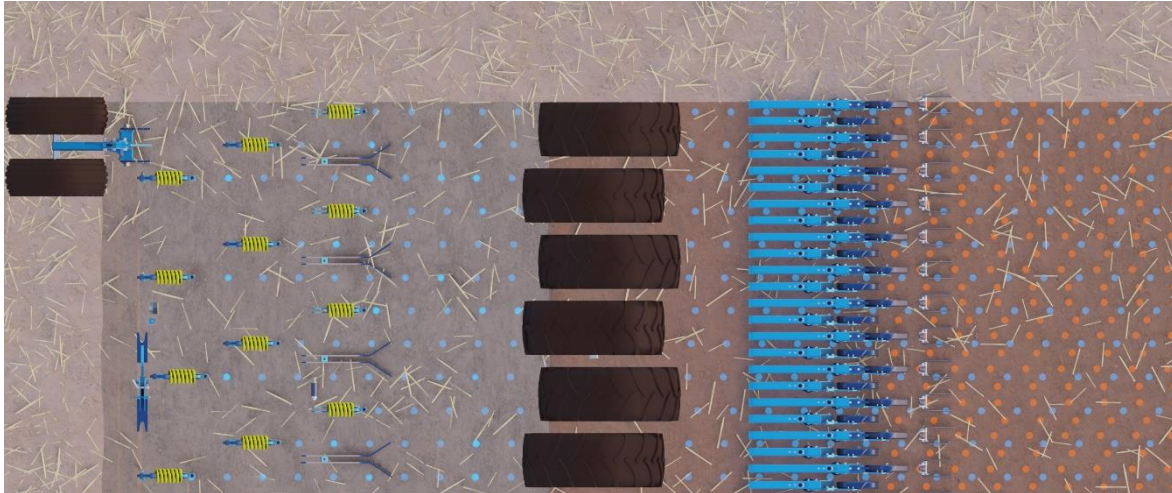

- To readjust the sowing section to STRIP technology, it is necessary to move the sowing section by half the spacing of the seed coulters **A**. This is done using the adjusting screw.
- For the coulters spacing 125 the sowing section is shifted by 62.5 mm, for the 150 mm spacing is by 75 mm. The locking segments are used for this.



IT IS NOT NECESSARY TO ADJUST THE MARKERS OR GPS.

2. Sowing STRIP, fertilizing in a row.

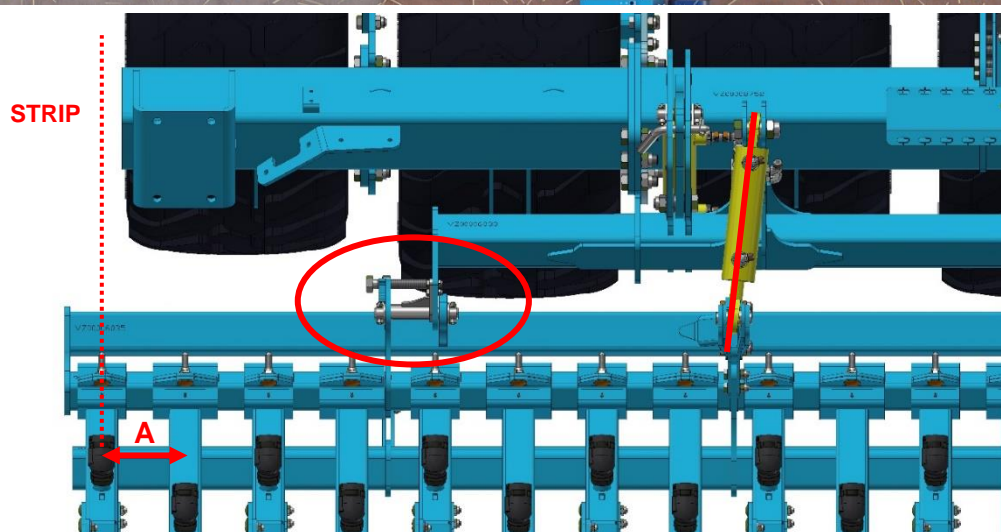
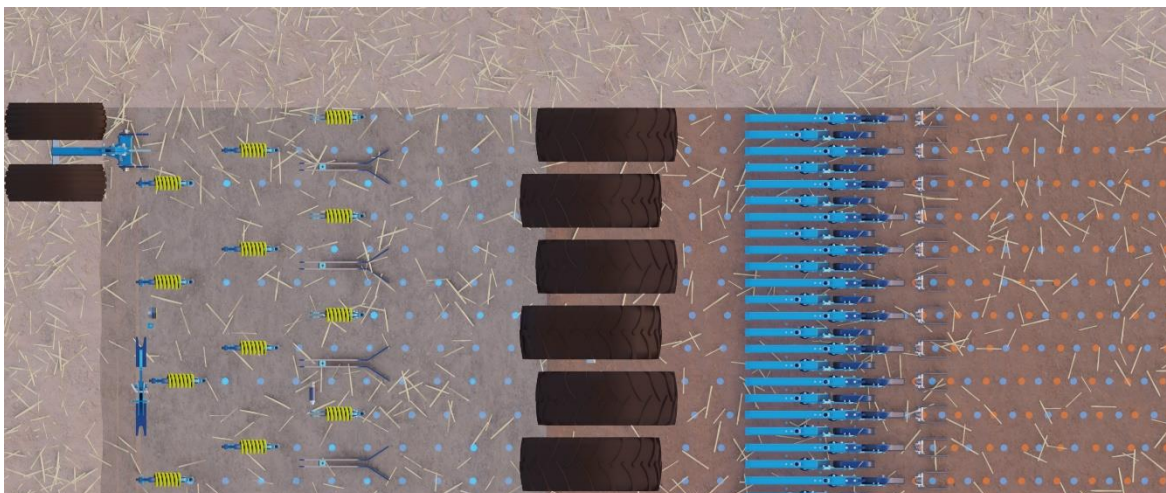

How to change to STRIP:

- 1) We release and remove the locking segment from the whole section.
- 2) All section displacement pins must be lubricated.
- 3) Insert the screw for moving the section (accessory).
- 4) From the left side, we will gradually start moving the section.
- 5) Refit the locking segment.

TECHNOLOGY STANDARD



TECHNOLOGY STRIP

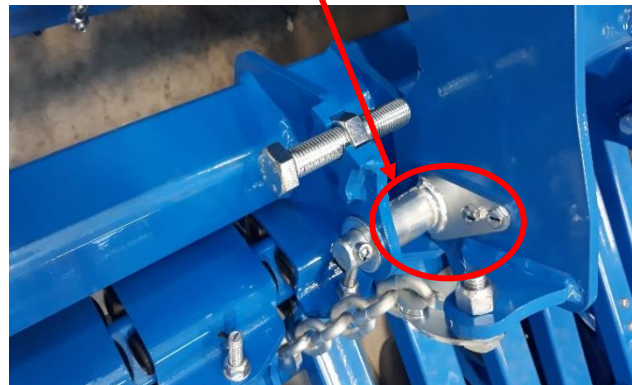

28 Hanging the machine on a crane

- For hanging it necessary to use fabric or rubber harnesses with sufficient load capacity. There is a risk of damaging the machine when using the chain.

Suspension point on the drawbar

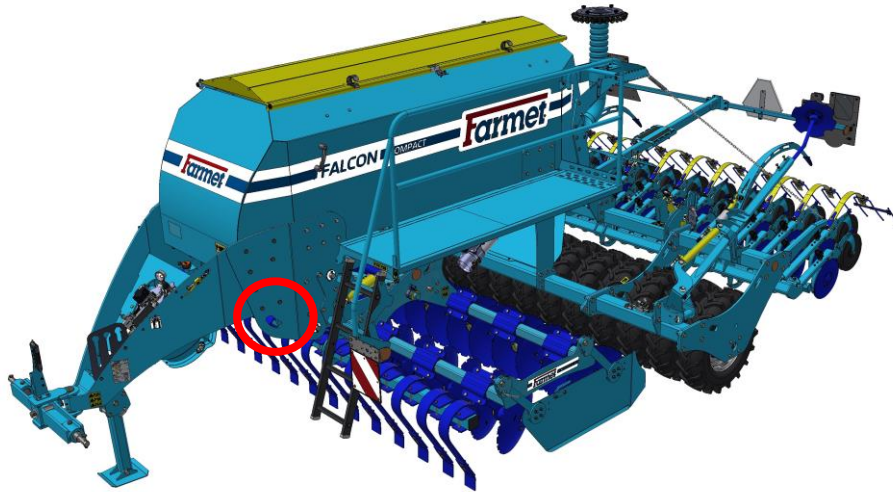

Suspension point on the rear frame



29 Error messages

29.1 ISO messages

ID	Alarm text	Possible cause	Possible remedy
001	The system has been stopped. A restart is required.	The connection to the SLAVE slave control unit has been interrupted. Download manager has been activated.	Disconnect and connect the control unit (disconnect the ISO connector).
002	The configuration has changed. The job computer restarts.	The configuration has changed.	Wait until the control unit restarts.
003	Input too high.	The value entered is too high.	Enter a lower value.
004	Input too low.	The value entered is too low.	Enter a higher value.
005	Error reading or writing data in flash memory of EEPROM.	An error occurred while starting the job computer.	Disconnect and connect the control unit (disconnect the ISO connector).
006	Data was successfully downloaded.		
007	A configuration error has been detected.	The configuration is incorrect.	Check the configuration.
008	The procedure is not permitted as long as the job is activated in the ISOBUS-TC application.	The job is activated in the ISOBUS-TC application.	Deactivate the order.
009	Speed signal lost from CAN bus.	The cable connection has been disconnected.	Check the cable connection.
010	Error initializing Control-Layer	The control-layer was incorrectly configured.	Check the configuration.
011	Multiple terminals have the same number.	There are several terminals with the same number (function instance) on ISOBUS.	Change the number (function instance) in the terminal.
012	Multiple TASK controllers have the same number.	There are several TASK controllers with the same number on ISOBUS.	Change the number.
013	The list of orders is full.	Too many orders are available in the order list.	Delete unnecessary orders.
014	Internal order recording stopped due to product change.	The product was changed during the recording of the internal order.	Select the original product.
015	The order failed to run because another product was assigned.	A different product than the one assigned to the tank in the configuration is stored in the order.	Check which product is correct and correct the order or assignment to hopper.

ID	Alarm text	Possible cause	Possible remedy
043	Dataset already exists.	An identical dataset already exists.	Check the dataset or change the name.
044	The dataset is defective.	There is an error in the dataset.	Check the dataset. Reinstall the software.
045	Dataset no found.	The selected dataset was not found. No calibration test has yet been performed for the selected product.	Choose another dataset or perform a calibration test for the selected product.
046	Loop overflow.	There is a conflict between the database and the machine.	You need to free up disc space on the terminal.
047	Database is full.	Database is empty.	First, delete the dataset to save the new one.
050	Display error.	The job computers display memory has detected an error.	Contact technical support.
060	The entry cannot be accepted. The value has been corrected.	The width of the arms is not divisible by the assigned sections.	Check the width of the arms and the number of sections.

29.2 Regulations alarms

ID	Alarm text	Possible cause	Possible remedy
400	The configured required blower speed is invalid. Product: xxxx.	The set required speed is outside the specified fan drive limits for the respective product.	Change the minimum and maximum limits of the required product speed.
401	The blower rotates too slowly.	The current fan speed is lower than the minimum allowed.	Increase fan speed.

ID	Alarm text	Possible cause	Possible remedy
402	The blower rotates too fast.	The current fan speed is higher than the value entered in the parameter „Blower speed tolerance“.	Reduce the fan speed or change the tolerance limit.
403	Pressure too high.	The pressure of the linear encoder is higher than the value of the “Maximum value” parameter.	Reduce the pressure or change the parameter “Maximum value”.
404	Pressure too low.	The pressure of the linear encoder is lower than the value of the “Minimum value” parameter.	Increase pressure or change parameter “Minimum value”.
405	Dosing has been stopped since the working position has not been reached. Excavate the sowing section.	The machine is not in the working position.	Excavate the sowing section.
406	Dosing was stopped because the machine was not completely raised. Excavate the sowing section.	The machine was not fully raised.	Excavate the sowing section.
407	The dispenser drive is stopped.	The current speed of the dosing drive is lower than the minimum speed.	Stop now! Eliminate the cause.
408	The metering shaft is stationary.	Speed sensor on the dosing shaft does not register any movement of the dosing shaft.	Stop now! Eliminate the cause.
410	The dispenser drive is outside the control area.	The current dosing drive speed is higher or lower than set speed.	Drive slower/faster or use a larger/smaller metering unit.
411	The dosing drive cannot comply with the setpoint.	You are driving too fast or too slow. It is not possible to reach the required value at the current speed.	Drive slower or faster so she can control unit to regulate the sowing rate.
412	The application has stopped due to a fatal error.	An error has occurred. This error always occurs in combination with another error.	Please fix the related error.
413	The application was stopped due to high driving speed.	Driving speed is too high.	Reduce the speed.

414	Dosing was stopped because the machine was not completely raised. Excavate the sowing section.	The machine was not fully raised.	Excavate the sowing section.
415	The blower rotates too fast. Dosing was stopped.	The current fan speed is higher than the value of the parameter "Max. rpm."	Reduce the fan speed or change the blower parameter "Max rpm."

ID	Alarm text	Possible cause	Possible remedy
416	The blower rotates too slowly. Dosing was stopped.	The current fan speed is lower than the value of the parameter "Min. rpm."	Increase the fan speed or change the blower parameter "Min. rpm".
417	The calibration flap is open. Please close it.	The calibration flap is open, although it is currently being sown.	Close the calibration flap.
418	The calibration flap is closed. Please open it.	The calibration flap is closed, although a calibration test is currently being performed.	Open the calibration flap.

29.3 Machine-specific alarms

ID	Alarm text	Possible cause	Possible remedy
602	Connection lost.	The connection to the ERC module has been lost.	Check the cables.
603	Connection disrupted.	The connection to the ERC module is interrupted.	Check the cables.
604	Supply voltage too low.	The supply voltage of the ERC modules is too low.	Check the supply voltage and check the vehicle battery.
605	Short circuit.	There is a short circuit in the ERC modules.	Check the cables.
606	Open load current circuit.	An open load circuit has been detected for the ERC modules.	Check the cables and make sure the disconnect connector is available.
607	Recognizes. ERC module error.	The configuration is incorrect.	Check the IN and OUT configuration.
608	Seed flow was not recognized.	The seed flow system did not detect any seed flow.	Check the seed flow system.
609	Seed flow was detected.	Seed flow occurred in the tramline.	Check the tramline switching. Kalpak tightness check.
611	Low tank level.	There is little seed or fertilizer in the hopper.	Fill the hopper.
612	The tank is empty.	There is no seed or fertilizer in the hopper.	Fill the hopper.
613	Exceeding the time when closing the section.	It takes too long to close the left section.	Make sure something is blocked.
617	Defective charger.	The charger alternator is defective.	Check the charger alternator.
618	No product flow was detected in the active row.	No product flow was detected in the active row.	Check the product flow, or some supply lines are blocked.
619	Too high flow detected in the active row.	Product flow detected too high was detected in the active row.	Check the calibration.
620	Product flow too low in the active row detected.	Too little product flow was detected in the active row.	Check the calibration.

ID	Alarm text	Possible cause	Possible remedy
621	Not available for this product no dataset.	A calibration test has not yet been performed for the product in question.	Perform a calibration test before working with the product.
622	The sowing test button is activated.	The sowing test button was activated before opening the calibration screen.	Release the sowing test button.
630	Connection lost.	The connection to the MRC module has been lost.	Check the cables.
631	Undefined module index.	A software error has occurred.	Contact customer service.
636	There is no seed for overdosing.	Too little seed was detected during pre-dosing.	Make sure that sufficient seed is available.
638	The engine stopped.	The MRC engine stopped.	Check the cables.
639	Current too high.	The MRC motor requires too much current.	Make sure something is blocked.
640	No speed was reached.	The MRC module did not reach the required speed.	Check the cables. Check the seed drills.
641	Power voltage too low.	The power voltage of the MRC module is too low.	Check the cables.
642	Electronics voltage too low.	The electronics voltage at the MRC module is too low.	Check the cables.
643	Sensor voltage too low.	The sensor voltage at the MRC module is too low.	Check the cables.
650	Connection lost.	The connection to the AIRidium® sensor has been disconnected.	Check the cables.
651	Undefined module index.	An error occurred of the AIRidium® module.	Contact customer service.
660	Connection lost.	The connection to the CAN Repeater has been disconnected.	Check the cables.
663	Drop below minimum voltage.	The voltage is lower than the pre-set minimum supply voltage.	Check wiring and supply voltage.
664	Sensor error detected PLANTirium®. Pollution rate too high.	The sensor is dirty. Sensitivity does not match the selected product.	Clean the sensor and/or change the sensitivity in the product.
665	An error has been detected in the PLANTirium® sensor. Faulty sensor transmitter.	The sensor transmitter is defective.	Check the cables on the sensor.
666	An error has been detected in the PLANTirium® sensor. Not achieved.	The minimum supply voltage has not been reached.	Check the cables.

ID	Alarm text	Possible cause	Possible remedy
667	Sensor error detected PLANTirium®. LIN-BUS communication error.	AQ LIN-Bus communication error has occurred. The sensor did not receive any messages from the LIN-Bus.	Check the cables.
668	Working speed is out of speed range.	Working speed is too high or too low.	Make sure you are within the speed range you found during the calibration test.
669	An error has been detected in the PLANTirium® sensor. Connection lost.	The connection to the PLANTirium® sensor has been disconnected.	Check the cables on the sensor.
670	Seed flow system error. Error: Sensor:	An error has occurred in the seed flow system.	Check the seed flow system.
671	Seed flow system error.	An error occurred in the seed flow system.	Check the seed flow system.
672	Product flow detected in inactive row.	Product flow detected in inactive row.	Check disconnection.
680	Connection lost.	The connection to the monitoring/control module has been disconnected.	Check cables.
681	Undefined module index.	An unconfigured monitoring/control module was found.	Check the number of configured or connected modules.
685	An error been detected in the control module.	Voltage drop, module error.	It is necessary to perform diagnostics and possible replacement of the module.
686	Supply voltage too low.	The supply voltage at the monitoring/control module is too low.	Check the cables.
688	The target value cannot be met. Seed coulter pressure.	The required setpoint for the linear actuator has not been reached.	Check the linear actuator for blockage.
689	The target value cannot be met. Working depth.	The required setpoint for the linear actuator has not been reached.	Check the linear actuator for blockage.
690	An error has been detected in the CAN repeater. 5V – Wrong voltage.	The CAN repeater is defective.	Contact customer service.
691	An error has been detected in the CAN repeater. 3.3 V – Wrong voltage.	The CAN-Defeater is defective.	Contact the customer service.
692	An error has been detected in the CAN repeater. 2.5 V – Wrong voltage.	The CAN-Defeater is defective.	Contact customer service.
693	Error detected in CAN-Repeater 12 VE- Faulty voltage.	The power supply to the electronics is defective.	Check the cables.



ID	Alarm text	Possible cause	Possible remedy
694	An error has been detected in the CAN repeater. 12 V – Faulty voltage.	The power supply voltage is defective.	Check the cables.
695	An error has been detected in the CAN repeater. Error converting AD.	The CAN-Repeater is defective.	Contact the customer service.
696	An error has been detected in the CAN repeater. Error entering address.	An error was detected during the addressing process.	Check the cables.
697	An error has been detected in the CAN repeater. Error in parameter block.	The CAN-Repeater is defective.	Contact customer service.

30 Machine maintenance and repairs

- Repairs to the machine may only be carried out by a trained person. When leaving the tractor cab, the operator must switch off all hydraulic circuits, appliances on the machine (fan) and the engine, the operator must prevent unauthorized access to the tractor.
- Worn discs are only replaced when the machine is at a standstill (means the machine is stationary and not working)
- If it is necessary to weld during repairs and have the machine connected to the tractor, the supply cables must be disconnected from the alternator and battery.
- Check the tightening of all screw and other mounting connections on the machine before each using of the machine.
- Continuously check the working parts of the machine for wear or replace these worn working parts with new ones.
- Adjustment, cleaning and lubrication of the machine may only be performed when the machine is at standstill (means the machine is stationary and not running).
- When working on the raised machine, use a suitable support device supported in suitable places.
- When adjusting, cleaning, maintaining and repairing the machine, you must secure those parts of the machine that could endanger the operator by falling or other movement.
- Repairs to the hydraulic circuits may only be carried out disassembled and the machine must be laid on the ground by the working units.
- When repairing the hydraulic circuits of the machine, it is first necessary to depressurize the hydraulic circuits of the machine.
- Use only the areas marked with self-adhesive labels with a chain symbol to catch the machine when handling with a lifting device „“.
- In the event of a fault or damage to the machine, switch off the tractor engine immediately and secure the engine against restarting, secure the machine against movement ⇒ only then you can remove the fault.
- Only use original spare parts, suitable tools and protective equipment when repairing the machine.
- Regularly check the prescribed tire pressure of the machine and the condition of the tires. Carry out any tire repairs in a specialist workshop.
- Keep the machine clean.
- **Do not clean hydraulic cylinders (piston rods), bearing and electronic parts with a high-pressure cleaner or a direct stream of water. Seals and bearing are not waterproof at high pressure.**



30.1 Maintenance plan

Maintenance plan					
Maintenance operation	Daily (season)	40 h	Before the season	After the season	Time interval
Generally a machine					
Visual inspection of the machine	X				
Monitoring of unwanted sounds, vibrations and excessive wear.	X				
Inspection of key nodes: pins, bearings, cylinders, working bodies	X			X	
Cleaning the machine					
Storage of the machine ideally under the roof.		X		X	
Record machine raid / season (ha)					
Complex visitation	X			X	
Frame inspection	X			X	
Do not clean hydraulic cylinders, bearings, electrical and electronic parts with a high-pressure cleaner or a direct stream of water. Seals and bearings are not waterproof at high pressure.					
					
Hydraulic system					
Check the function, tightness, fastening and abrasions of all hydraulic components and hoses		X	X		
Hydraulic hoses – replacement:					
Damage hose outer casing (mechanically or swollen)					
Fluid leakage (especially at the tip)	X			X	
Bumps or blisters on the hose					
Deformed or corroded terminal					
Loose end – the hose rotates					
Hydraulic hose– replacement:					
Hose life exceeded					6 years
					
PREVENTION means to eliminate the problem planned, out of season without stress and comfortable before a secondary problem, accident or health threat arises.					

Maintenance plan											
Maintenance operation	Daily (season)	40 h	Before the season	After the season	Time interval						
Screw connections											
Visual inspection of screw and hydraulic connections, tighten loose connections with the appropriate tightening torque (table of tightening torques)	X			X							
Wheels – Tighten all wheel nuts. For the first time after 10 hours of operation. After changing the wheel after 10 hours of operation		X	X								
<table border="1"> <tr> <td>M 18 x 1,5</td> <td>300 Nm</td> </tr> <tr> <td>M 20 x 1,5</td> <td>400 Nm</td> </tr> <tr> <td>M 22 x 1,5</td> <td>500 Nm</td> </tr> </table>	M 18 x 1,5	300 Nm	M 20 x 1,5	400 Nm	M 22 x 1,5	500 Nm					
M 18 x 1,5	300 Nm										
M 20 x 1,5	400 Nm										
M 22 x 1,5	500 Nm										
Brake system											
Brake lines and hoses – check function, tightness, fastening and clamping or breakage	X		X								
Brake components – check function, tightness, fastening	X		X								
Aerator – drainage by drain valve		X									
Drain valve – verification of functionality, cleaning and replacement of seals				X							
Pipe filter – cleaning				X							
Brake/parking brake – functional check, step adjustment 25-45 mm	X		X								
Brake lining – check the condition of the brake lining, min. thickness 3 mm			X								
Wheels / axle											
Tire pressure check	X		X	X							
Transport axle bearings – check and possible adjustment of play (work in the workshop)				X							

Maintenance plan					
Maintenance operation	Daily (season)	40 h	Before the season	After the season	Time interval
Pneumatic system					
Fan: Speed setting function	X		X		
PTO fan – check oil level.		X	X		
PTO oil change The first after 50 operating hours The second after 200 operating hours Others after 400 hours					1 year
Fan protection grille: condition check, dirt removal	X				
Oil cooler		X			
Fan impeller Condition check and fastening, dirt removal Check the fan drive mounting		X			
Fan, seeding hose, mixer: Tightness, clamping points, clogging, general condition	X			X	
Hydraulic couplings and hoses: Tightness of all components and permeability	X				
Distributor: Foreign matter control. Unscrew the distributor cover and check the outlets Check the function and position of the tramline flaps	X				
Sowing device (dispenser)					
Checking the overall condition, adjustment, wear, tightness			X		
Checking for the presence of foreign bodies	X				
Check the condition of the drive, motor bearings		X			
Check the tightness of the plate on the roller			X		
PREVENTION means to eliminate the problem planned, out of season without stress and comfortably before a secondary problem, accident or health threat arises.					

Maintenance plan					
Maintenance operation	Daily (season)	40 h	Before the season	After the season	Time interval
Damage check, possible replacement		X	X		
Safety device					
Lighting and safety hatched boards – check condition, functionality and cleanliness	X		X		
Warning and safety labels – presence and legibility check		X			
Lubrication schedule of the machine					
Drawbar joint/suspension eye - grease	X			X	
Parking brake bolt – grease or suitable oil	X			X	
Axle bearings – grease containing LITHIUM – inspection, possible filling				X	
After season					
<p>The whole machine</p> <p>Perform treatment and cleansing; do not spray plastic parts with oil or similar means</p> <p>Spray the piston rods of the hydraulic cylinders with suitable anti-corrosion agents</p> <p>Check the strength of all screw and plug-in connections (see table of tightening torques)</p> <p>Check electrical wiring for damage and replace if necessary</p>					
<p>Brake system</p> <p>Before the last ride, preserve with antifreeze (approx. 0,1l) without ethanol, use the one recommended by the tractor manufacturer</p> <p>Secure the machine against movement with wheel chocks</p> <p>Release the parking brake, bleed the air and close the brake lines</p> <p>The service and parking brakes must be released during the winter to prevent them from sticking to the brake drum</p>					
<p>Lubrication points</p> <p>Lubricate the lubrication points according to the lubrication schedule, with KP2P-20 Likx grease according to DIN 51 502</p>					
<p>PREVENTION means to eliminate the problem planned out of the season without stress and comfortably before a secondary problem, accident or health threat arises.</p>					

30.1.1 Lubricant nadling

- Treat lubricants and oils as hazardous waste in accordance with applicable laws and regulations.
- Protect yourself from direct contact with oils and lubricants by using gloves or protective creams.
- Wash oil marks on the skin thoroughly with warm water and soap. Do not clean the skin with petrol, diesel or other solvents.
- Oil or grease is toxic. If you have swallowed oil or grease, see a doctor immediately.
- Protect children from contact with lubricants and oils.

30.1.2 Tire pressure

Load of an empty machine on axle			
Tire	from	to	Tire pressure
Mitas 405/70R20	0 kg	7 920 kg	1,5 Bar
	7 920 kg	10 242 kg	2,0 Bar
	10 242 kg	12 306 kg	2,5 Bar
	12 306 kg	14 280 kg	3,0 Bar
Mitas 420/65R20	0 kg	6 570 kg	0,6 Bar
	6 570 kg	7 530 kg	0,8 Bar
	7 530 kg	8 460 kg	1,0 Bar
	8 460 kg	9 330 kg	1,2 Bar
	9 330 kg	10 350 kg	1,4 Bar
	10 350 kg	11 400 kg	1,6 Bar

30.1.3 Recommended tightening torques

Screw connection	Tightening torque	Note
M8x1	8Nm	Mounting screws of housing bearing
M8 (8.8)	25Nm	
M12 (8.8)	87Nm	Housing bearings
M16 (8.8)	210Nm	Pneumatic cylinder wheels
M 20 (8.8)	50Nm	Swivel harrow bolts
M20 (8.8)	410Nm	Locking bolts, pneumatic cylinder wheels axles
M24 (8.8)	710Nm	Tray screws
Hydraulic + air connections		
M16x1,5	60Nm	Hydraulic fittings, air fittings
M22x1,5	140Nm	Hydraulic fittings, air fittings

31 Shutting down the machine

Shutting down the machine for a longer period of time:

- Park the machine under a roof if possible.
- Park the machine on a level and firm surface with sufficient capacity.
- Before storing the machine, remove dirt and preserve it so that the machine does not suffer any damage during storage. Pay special attention to all marked lubrication points and lubricate them properly according to the lubrication schedule.
- Park the machine in the transport position with the frames folded down. Park the machine on the axle and parking leg, secure the machine against unintentional movement with wheel chocks or other suitable aids.
- The machine must not rest on the discs. There is a risk of damaging the machine's discs.
- Secure the machine against unauthorized access.

32 Environmental protection

- Regularly check the hydraulic system for leaks.
- Preventive replacement or repair of hydraulic hoses or other parts of the hydraulic system showing signs of damage before an oil leak occurs.
- Check the condition of the hydraulic hoses and replace them in good time. The service life of hydraulic hoses also includes the time for which they were stored.
- Dispose of oils and fats in accordance with applicable waste laws and regulations.

33 End of life machine disposal

- When disposing of the machine, the operator must ensure that steel parts and parts in which hydraulic oil or grease moves are distinguished.
- The operator must cut the steel parts in accordance with the safety regulations and hand them in at a collection point for secondary raw materials. They must proceed with other parts in accordance with the applicable waste laws.

34 Service and warranty conditions

34.1 Service favor

Service is provided by a sales representative, after consultation with the manufacturer or the manufacturer directly. Spare parts through the sales network by individual dealers throughout the country. Use spare parts only in accordance with the spare parts catalog officially issued by the manufacturer.

34.2 Guarantee

Machine with registration for MY Farmet, warranty 24 months.

Machine without registration, 12 months warranty.

- The manufacturer provides a 24-month warranty on the following machine parts: main frame, axle and drawbar of the machine. The manufacturer provides a 12-month warranty on other parts of the machine. The warranty is provided from the date of sale of the new machine to the final consumer (user).
- The warranty covers hidden defects that appear during the warranty period when the machine is used properly and when the conditions specified in the instructions for use are met.
- The warranty does not apply to wear parts, normal mechanical wear of replaceable parts of working parts (coulters, blades, etc.).
- The warranty does not cover indirect consequences of possible damage, such as reduced service life, etc.
- The warranty is tied to the machine and does not expire with a change of owner.
- The warranty is limited to disassembly and assembly, or replacement or repair of the defective part. The decision whether a defective part will be replaced or repaired belongs to the Farmet contract workshop.
- During the warranty period, repairs or other interventions on the machine may only be carried out by the manufacturers authorized service technician. Otherwise, the warranty will not be recognized. This provision does not apply to the replacement of wear parts.
- The warranty is conditional on the use of original spare parts from the manufacturer.

ⒸZ ES PROHLÁŠENÍ O SHODĚ

ⒸGB CE CERTIFICATE OF CONFORMITY

ⒸD EG-KONFORMITÄTSEKTLÄRUNG

ⒸF DÉCLARATION CE DE CONFORMITÉ

ⒸRU СЕРТИФИКАТ СООТВЕТСТВИЯ ЕС

ⒸPL DEKLARACJA ZGODNOŚCI WE

1. ⒸZ My ⒸGB We ⒸD Wir ⒸF Nous ⒸRU Мы ⒸPL My: **Farmet a.s.**
 Jiřinková 276
 552 03 Česká Skalice
 Czech Republic
 DIČ: CZ46504931
 Tel/Fax: 00420 491 450136

ⒸZ Vydáváme na vlastní zodpovědnost toto prohlášení. ⒸGB Hereby issue, on our responsibility, this Certificate. ⒸD Geben in alleiniger Verantwortung folgende Erklärung ab. ⒸF Publiions sous notre propre responsabilité la déclaration suivante. ⒸRU Под свою ответственность выдаем настоящий сертификат. ⒸPL Wydajemy na własną odpowiedzialność niniejszą Deklarację Zgodności.

2. ⒸZ Strojní zařízení: - název : **Diskový sečí stroj**
 ⒸGB Machine: - name : **Disc sowing machine**
 ⒸD Fabrikat: - Bezeichnung : **Scheibensämaschine**
 ⒸF Machinerie: - dénomination : **Semeuse à disques**
 ⒸRU Сельскохозяйственная машина: - наименование : **Дисковая сеялка**
 ⒸPL Urządzenie maszynowe: - nazwa : **Siewnik talerzowy**
- typ, type : **FALCON**
 - model, modèle : **FALCON 3; 4; 6; 8**
 - PIN/VIN
- ⒸZ výrobní číslo :
 - ⒸGB serial number
 - ⒸD Fabriknummer
 - ⒸF n° de production
 - ⒸRU заводской номер
 - ⒸPL numer produkcyjny

3. ⒸZ Příslušná nařízení vlády: č.176/2008 Sb. (směrnice 2006/42/ES). ⒸGB Applicable Governmental Decrees and Orders: No.176/2008 Sb. (Directive 2006/42/ES). ⒸD Einschlägige Regierungsverordnungen (NV): Nr.176/2008 Slg. (Richtlinie 2006/42/ES). ⒸF Décrets respectifs du gouvernement: n°.176/2008 du Code (directive 2006/42/CE). ⒸRU Соответствующие постановления правительства: № 176/2008 Сб. (инструкция 2006/42/ES). ⒸPL Odpowiednie rozporządzenia rządowe: nr 176/2008 Dz.U. (Dyrektywa 2006/42/WE).

4. ⒸZ Normy s nimiž byla posouzena shoda: ⒸGB Standards used for consideration of conformity: ⒸD Das Produkt wurde gefertigt in Übereinstimmung mit folgenden Normen: ⒸF Normes avec lesquelles la conformité a été évaluée: ⒸRU Нормы, на основании которых производилась сертификация: ⒸPL Normy, według których została przeprowadzona ocena: ČSN EN ISO 12100, ČSN EN ISO 4254-1, ČSN EN 14018+A1.

ⒸZ Schválil ⒸGB Approve by Утвердил ⒸPL on: 01.07.2020
 ⒸD Bewilligen ⒸF Approuvé Uchwalil ⒸRU

Ing. Petr Lukášek
 Technical director

In České Skalice on: 01.07.2020

Ing. Karel Žďárský
 General Manager